

JLX350-01901-BN 使用说明书

(插接式 FPC)

目 录

序号	内 容 标 题	页 码
1	概述	2
2	特点	2
3	外形及接口引脚功能	3~4
4	基本原理	4
5	技术参数	4~5
6	时序特性	5~7
7	指令功能及硬件接口与编程案例	8~末页

1. 概述

晶联讯电子专注于液晶屏及液晶模块的研发、制造。所生产 JLX350-01901 型 TFT 模块由于使用方便、显示清晰，广泛应用于各种人机交流面板。

JLX350-01901 可以显示 320 列*480 行点阵彩色图片，或显示 20 个/行*30 行 16*16 点阵的汉字，或显示 40 个/行*60 行 8*8 点阵的英文、数字、符号。

2. JLX350-01901 图像型点阵 TFT 模块的特性

2.1 结构轻、薄、带背光。

2.2 IC 采用 ST7796S, 功能强大，稳定性好

2.3 显示内容：

- 320*480 点阵彩色图片；

- 可選用 32*32 点阵或其他点阵的图片来自编汉字，按照 32*32 点阵汉字来计算可显示 10 个字/行*15 行。

- 可選用 16*16 点阵或其他点阵的图片来自编汉字，按照 16*16 点阵汉字来计算可显示 20 个字/行*30 行。

2.4 指令功能强：例如可以用指令控制显示内容顺时针旋转 90、逆时针旋转 90° 或倒立竖放。

2.5 接口方式：并口 8080 时序、串口。

2.6 工作温度宽：-20℃ - +70℃；

2.7 工作温度宽：-30℃ - +80℃；

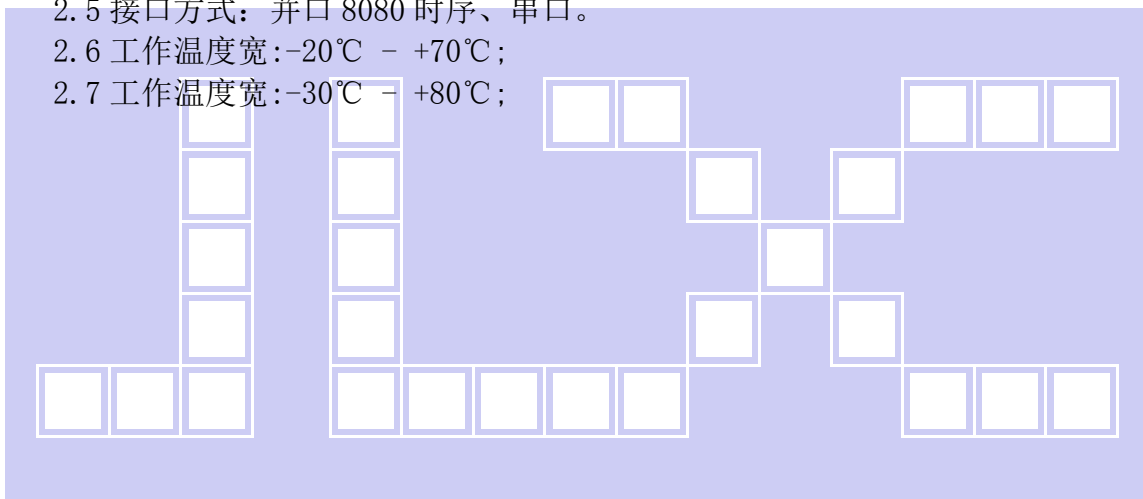

3. 外形尺寸及接口引脚功能



图 1. 带背光的 TFT 模块外形尺寸

模块的接口引脚功能

引线号	符号	名称	功能
1	GND	接地	0V
2	VDD	供电电源正极	供电电源正极 3.3V
3	CS	片选	低电平片选
4	RS	寄存器选择信号	H:数据寄存器 0:指令寄存器
5	WR/SCL	写	并口: 写功能; 串口: 串行时钟
6	RD	读	并口: 读功能, 串口: 建议接 VDD 或 VSS
7	SDA	串行数据	并口: 空
8	SDO	串行数据	串口: SDA 和 SDO 短接一起, 做串行数据
9	DB0	I/O	并口: 数据总线 DB0, 串口: 建议接 VDD 或 VSS
10	DB1	I/O	并口: 数据总线 DB1, 串口: 建议接 VDD 或 VSS
11	DB2	I/O	并口: 数据总线 DB2, 串口: 建议接 VDD 或 VSS
12	DB3	I/O	并口: 数据总线 DB3, 串口: 建议接 VDD 或 VSS
13	DB4	I/O	并口: 数据总线 DB4, 串口: 建议接 VDD 或 VSS
14	DB5	I/O	并口: 数据总线 DB5, 串口: 建议接 VDD 或 VSS
15	DB6	I/O	并口: 数据总线 DB6, 串口: 建议接 VDD 或 VSS
16	DB7	I/O	并口: 数据总线 DB7, 串口: 建议接 VDD 或 VSS
17	RST	复位	低电平复位, 复位完成后, 回到高电平, TFT 模块开始工作
18	IM2/PS	接口方式选择	并口: VSS 串口: VDD
19	LEDA	背光电源正极	接 3.0V (接 3.3V 串 10 欧电阻, 接 5.0V 串 39 欧电阻)
20	LEDK	背光电源负极	接 GND

表 1: 模块的接口引脚功能

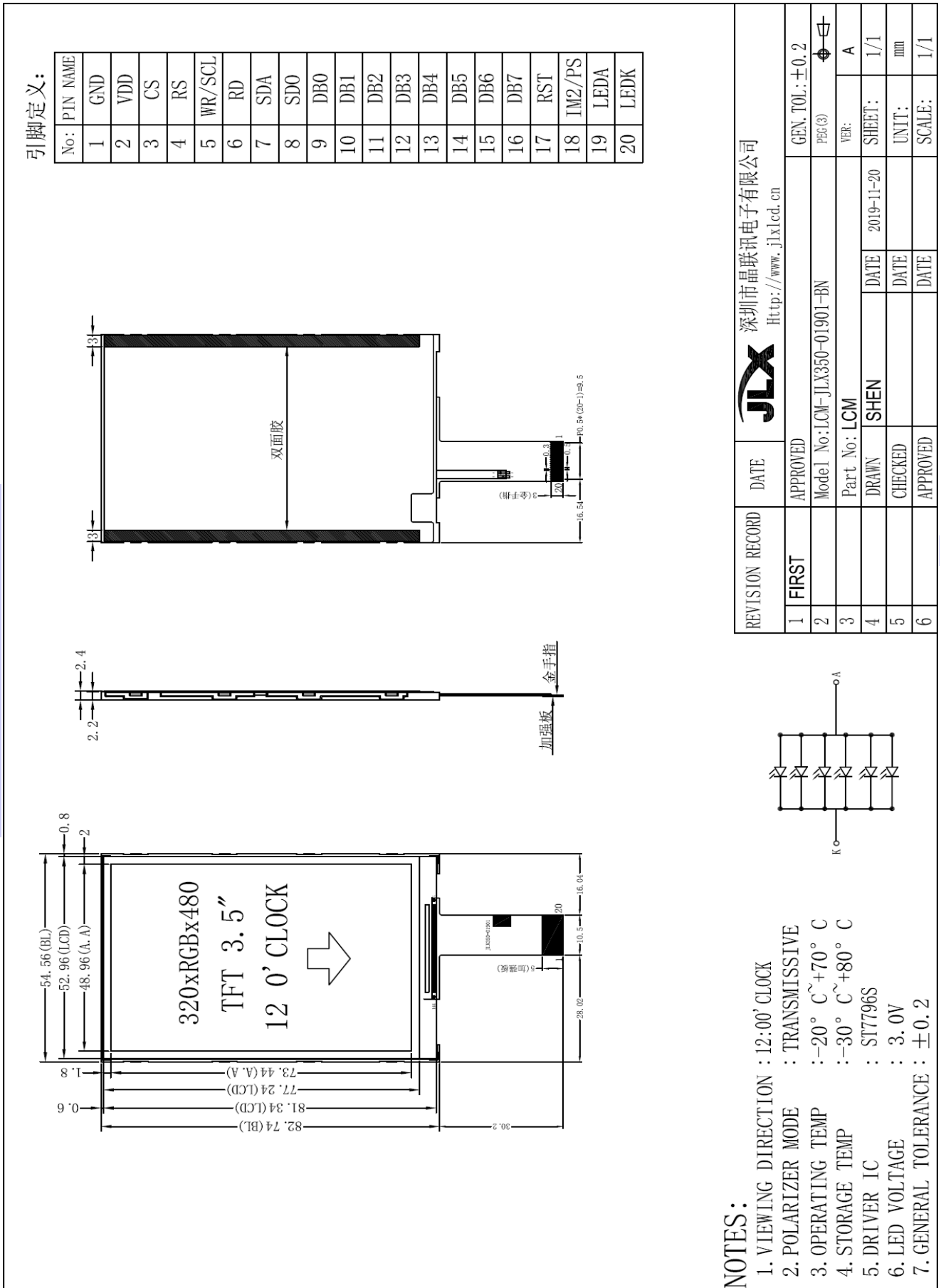
4. 基本原理

4.1 TFT 屏 (LCD)

在 LCD 上排列着 320×480 点阵, 320 个列信号与驱动 IC 相连, 480 个行信号也与驱动 IC 相连, IC 邦定在 LCD 玻璃上 (这种加工工艺叫 COG)。

4.2 背光参数

该型号 TFT 模块带 LED 背光源。它的性能参数如下:

工作温度: -20~+70° C;

存储温度: -30~+80° C;

背光板是白色。

正常工作电流为: 48~120mA (LED 灯数共 6 颗, 每颗灯是 10~20 mA)

工作电压: 3.0V (接 3.3V 串 10 欧以上电阻, 接 5.0V 串 39 欧以上电阻)

5. 技术参数

5.1 最大极限参数 (超过极限参数则会损坏 TFT 模块)

名称	符号	标准值			单位
		最小	典型	最大	
电路电源	VDD - VSS	-0.3	3.0	3.3	V
工作温度		-20		+70	°C

储存温度		-30		+80	°C
------	--	-----	--	-----	----

表 2: 最大极限参数

5.2 直流 (DC) 参数

名称	符号	测试条件	标准值			单位
			MIN	TYPE	MAX	
工作电压	VDD		2.4	3.0	3.3	V
背光工作电压	VLED		2.9	3.0	3.1	V
输入高电平	V_{IH}	-	$0.8 \times VDD$	-	VDD	V
输入低电平	V_{IL}	-	VSS	-	$0.2 \times VDD$	V
输出高电平	V_{OH}	$I_{OH} = -0.5\text{mA}$	$0.8 \times VDD$	-	VDD	V
输出低电平	V_{OL}	$I_{OL} = -0.5\text{mA}$	VSS	-	$0.2 \times VDD$	V
模块工作电流	I_{DD}	VDD = 3.3V	-		0.3	mA
背光工作电流	I_{LED}	VLED=3.0V	48	90	120	mA

表 3: 直流 (DC) 参数

6. 读写时序特性

6.1 8080 读写时序特性

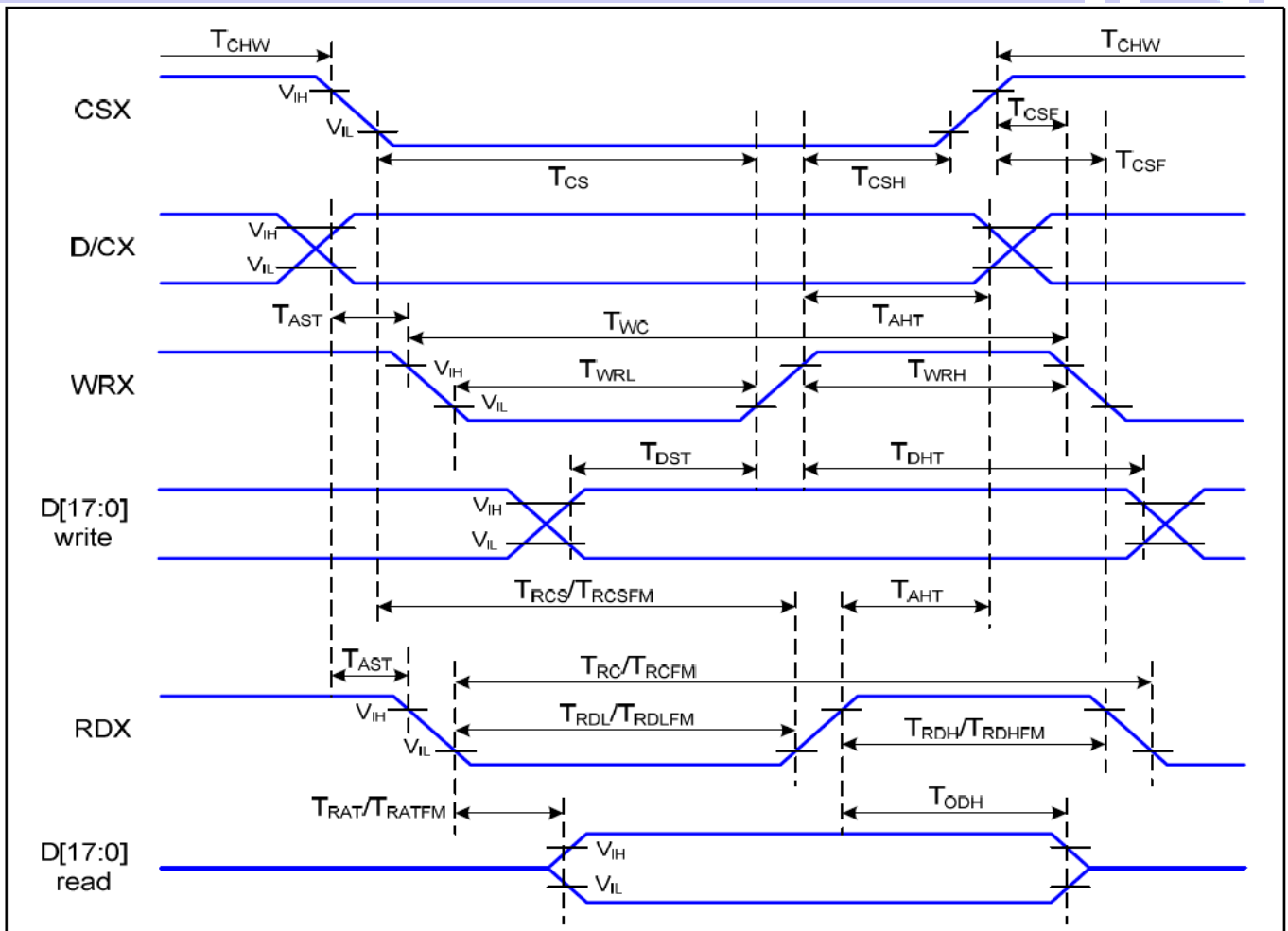

Parallel Interface Timing Characteristics (8080-Series MCU Interface)

图 2. 8080 时序图

6.2 8080 时序要求 (AC 参数):
表 4.

项目	符号	测试条件	极限值			单位
			MIN	TYPE	MAX	
地址保持时间	A0	T_{Aht}	10	—	—	ns
地址建立时间		T_{Ast}	0	—	—	
芯片选择“高”脉冲宽度	CS	T_{CHW}	0			
芯片选择建立时间(写)		T_{CS}	15			
芯片选择建立时间(读)		T_{RCS}	45			
芯片选择保持时间	WR	T_{CSH}	10			
写周期		T_{WC}	66			
控制脉冲“高”持续时间		T_{WRH}	15			
控制脉冲“低”持续时间		T_{WRL}	15			
芯片选择保持时间	RD	T_{CSH}	10			
读周期		T_{RC}	160			
控制脉冲“高”持续时间		T_{RDH}	90			
控制脉冲“低”持续时间		T_{RDL}	45			
数据建立时间		D7-D0	T_{DST}	10		
数据保持时间	T_{DHT}		10			
读取时间	T_{RAT}			40		
输出禁用时间	T_{ODH}		20	80		

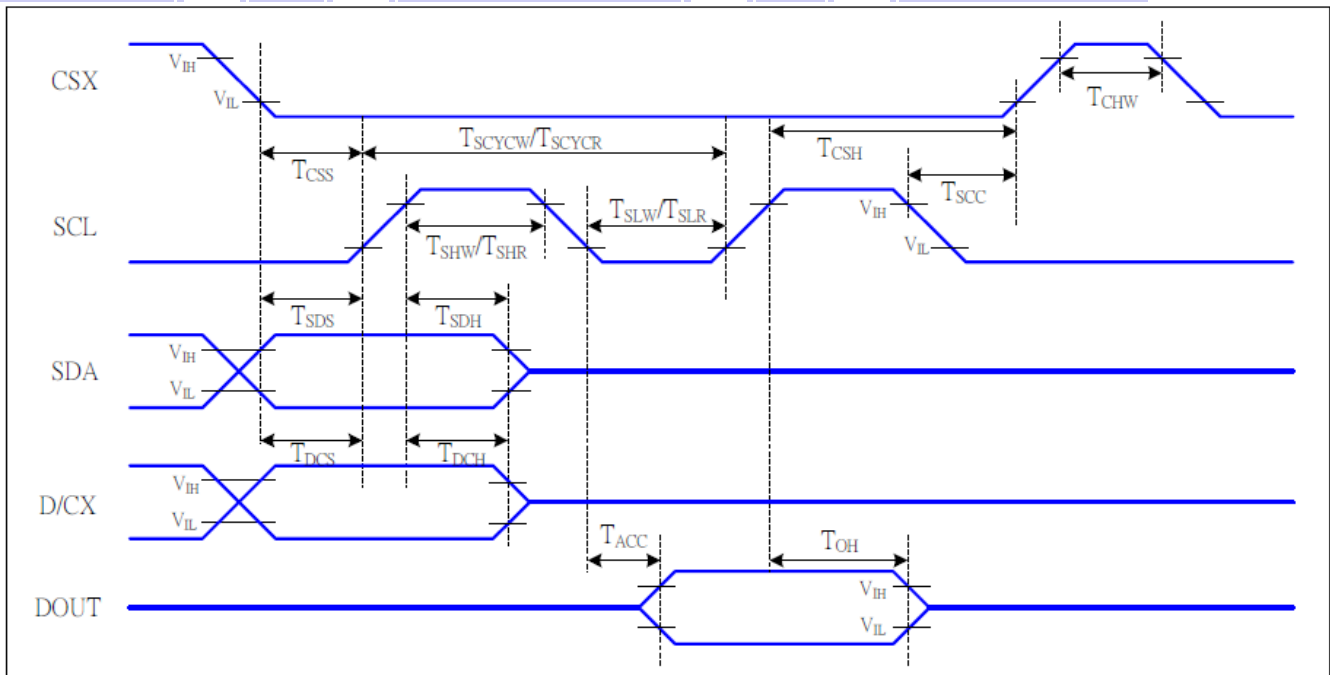
 $V_{DD}=3.3V$ $T_a=25^{\circ}C$
6.3 4_SPI 读写时序特性

4-SPI Interface Timing Characteristics

6.4 4_SPI 时序要求 (AC 参数):

Signal	Symbol	Parameter	MIN	MAX	Unit	Description
CSX	T_{CSS}	Chip select setup time (write)	15		ns	
	T_{CSH}	Chip select hold time (write)	15		ns	
	T_{CSS}	Chip select setup time (read)	60		ns	
	T_{SCC}	Chip select hold time (read)	65		ns	
	T_{CHW}	Chip select "H" pulse width	40		ns	
SCL	T_{SCYCW}	Serial clock cycle (Write)	66		ns	-write command & data ram
	T_{SHW}	SCL "H" pulse width (Write)	15		ns	
	T_{SLW}	SCL "L" pulse width (Write)	15		ns	
	T_{SCYCR}	Serial clock cycle (Read)	150		ns	-read command & data ram
	T_{SHR}	SCL "H" pulse width (Read)	60		ns	
	T_{SLR}	SCL "L" pulse width (Read)	60		ns	
D/CX	T_{DCS}	D/CX setup time	10		ns	
	T_{DCH}	D/CX hold time	10		ns	
SDA (DIN)	T_{SDS}	Data setup time	10		ns	
	T_{SDH}	Data hold time	10		ns	
DOUT	T_{ACC}	Access time	10	50	ns	For maximum CL=30pF
	T_{OH}	Output disable time	15	50	ns	For minimum CL=8pF

6.5 电源启动后复位的时序要求 (RESET CONDITION AFTER POWER UP):



图 3: 电源启动后复位的时序

表 5: 电源启动后复位的时序要求

VDD=3.3V, Ta = 25°C

项目	符号	测试条件	极限值			单位
			MIN	TYPE	MAX	
复位时间	t_R		--	--	120	ms
复位保持低电平的时间	t_{RW}	引脚: RES	10	--	--	us

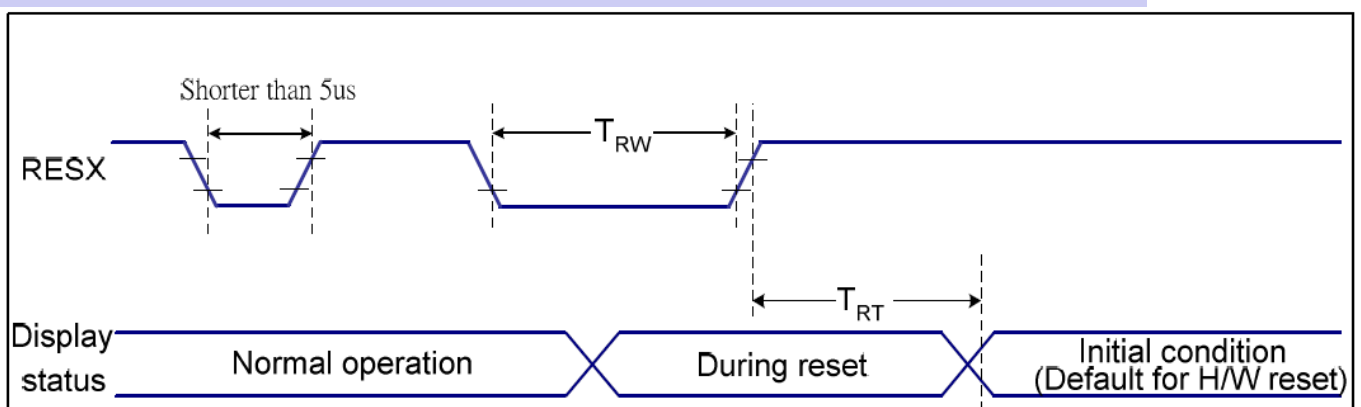
7. 指令功能:

7.1 指令表

COMMAND Table 1														
Instruction	D/CX	WRX	RDX	D17-8	D7	D6	D5	D4	D3	D2	D1	D0	Hex	Function
NOP	0	↑	1	-	0	0	0	0	0	0	0	0	(00h)	No operation
SWRESET	0	↑	1	-	0	0	0	0	0	0	0	1	(01h)	Software reset
RDDID	0	↑	1	-	0	0	0	0	0	1	0	0	(04h)	Read display ID
	1	1	↑	-	-	-	-	-	-	-	-	-		Dummy read
	1	1	↑	-	ID17	ID16	ID15	ID14	ID13	ID12	ID11	ID10		ID1 read
	1	1	↑	-	ID27	ID26	ID25	ID24	ID23	ID22	ID21	ID20		ID2 read
	1	1	↑	-	ID37	ID36	ID35	ID34	ID33	ID32	ID31	ID30		ID3 read
Read Number of the Errors on DSI	0	↑	1		0	0	0	0	0	1	0	1	(05h)	Read DSI
	1	1	↑	-	-	-	-	-	-	-	-	-		Dummy read
	1	1	↑		D7	D6	D5	D4	D3	D2	D1	D0		
RDDST	0	↑	1	-	0	0	0	0	1	0	0	1	(09h)	Read display status
	1	1	↑	-	-	-	-	-	-	-	-	-		Dummy read
	1	1	↑	-	BSTON	MY	MX	MV	ML	RGB	ST25	ST24		-
	1	1	↑	-	ST23	IFPF2	IFPF1	IFPF0	IDMON	PTLON	SLOUT	NORON		-
	1	1	↑	-	Vscroll	ST14	INVON	ALLON	ALLOFF	DISON	TEON	GCS2		-
	1	1	↑	-	GCS1	GCS0	TEM	ST4	ST3	ST2	ST1	ST0		-
RDDPM	0	↑	1	-	0	0	0	0	1	0	1	0	(0Ah)	Read display power
	1	1	↑	-	-	-	-	-	-	-	-	-		Dummy read
	1	1	↑	-	BSTON	IDMON	PTLON	SLPOUT	NORON	DISON	0	0		
RDD MADCTL	0	↑	1	-	0	0	0	0	1	0	1	1	(0Bh)	Read display
	1	1	↑	-	-	-	-	-	-	-	-	-		Dummy read
	1	1	↑	-	MY	MX	MV	ML	RGB	DISDL	0	0		-
RDD Interface Pixel Format	0	↑	1	-	0	0	0	0	1	1	0	0	(0Ch)	Read display pixel
	1	1	↑	-	-	-	-	-	-	-	-	-		Dummy read
	1	1	↑	-	R3	R2	R1	R0	0	D2	D1	D0		-

COMMAND Table 1														
Instruction	D/CX	WRX	RDX	D17-8	D7	D6	D5	D4	D3	D2	D1	D0	Hex	Function
RDDIM	0	↑	1	-	0	0	0	0	1	1	0	1	(0Dh)	Read display image
	1	1	↑	-	-	-	-	-	-	-	-	-		Dummy read
	1	1	↑	-	VSSON	0	INVON	0	0	GC2	GC1	GC0		-
RDDSM	0	↑	1	-	0	0	0	0	1	1	1	0	(0Eh)	Read display signal
	1	1	↑	-	-	-	-	-	-	-	-	-		Dummy read
	1	1	↑	-	TEON	TEM	HSYN	VSYN	PIXCLK	DATEN	0	DSIER		-
RDDSDR	0	↑	1	-	0	0	0	0	1	1	1	1	(0Fh)	Read display self-diagnostic result
	1	1	↑	-	-	-	-	-	-	-	-	-		Dummy read
	1	1	↑	-	D7	D6	0	0	0	0	0	D0		-
SLPIN	0	↑	1	-	0	0	0	1	0	0	0	0	(10h)	Sleep in
SLPOUT	0	↑	1	-	0	0	0	1	0	0	0	1	(11h)	Sleep out
PTLON	0	↑	1	-	0	0	0	1	0	0	1	0	(12h)	Partial mode on
NORON	0	↑	1	-	0	0	0	1	0	0	1	1	(13h)	Partial off (Normal)
INVOFF	0	↑	1	-	0	0	1	0	0	0	0	0	(20h)	Display inversion off
INVON	0	↑	1	-	0	0	1	0	0	0	0	1	(21h)	Display inversion on
DISPOFF	0	↑	1	-	0	0	1	0	1	0	0	0	(28h)	Display off
DISPON	0	↑	1	-	0	0	1	0	1	0	0	1	(29h)	Display on
CASET	0	↑	1	-	0	0	1	0	1	0	1	0	(2Ah)	Column address set
	1	↑	1	-	XS15	XS14	XS13	XS12	XS11	XS10	XS9	XS8		X address start:
	1	↑	1		XS7	XS6	XS5	XS4	XS3	XS2	XS1	XS0		$0 \leq XS \leq X$
	1	↑	1		XE15	XE14	XE13	XE12	XE11	XE10	XE9	XE8		X address start:
	1	↑	1		XE7	XE6	XE5	XE4	XE3	XE2	XE1	XE0		$S \leq XE \leq X$

COMMAND Table 1														
Instruction	D/CX	WRX	RDX	D17-8	D7	D6	D5	D4	D3	D2	D1	D0	Hex	Function
RASET	0	↑	1	-	0	0	1	0	1	0	1	1	(2Bh)	Row address set
	1	↑	1	-	YS15	YS14	YS13	YS12	YS11	YS10	YS9	YS8		Y address start: $0 \leq YS \leq Y$
	1	↑	1		YS7	YS6	YS5	YS4	YS3	YS2	YS1	YS0		Y address start: $S \leq YE \leq Y$
	1	↑	1		YE15	YE14	YE13	YE12	YE11	YE10	YE9	YE8		Y address start: $S \leq YE \leq Y$
RAMWR	0	↑	1	-	0	0	1	0	1	1	0	0	(2Ch)	Memory write
	1	↑	1	-	D7	D6	D5	D4	D3	D2	D1	D0		Write data
RAMRD	0	↑	1	-	0	0	1	0	1	1	1	0	(2Eh)	Memory read
	1	1	↑	-	-	-	-	-	-	-	-	-		Dummy read
	1	1	↑	-	D7	D6	D5	D4	D3	D2	D1	D0		Read data
PTLAR	0	↑	1	-	0	0	1	1	0	0	0	0	(30h)	Partial start/end address set
	1	↑	1	-	PSL15	PSL14	PSL13	PSL12	PSL11	PSL10	PSL9	PSL8		Partial start address: (0, 1, 2, ...P)
	1	↑	1	-	PSL7	PSL6	PSL5	PSL4	PSL3	PSL2	PSL1	PSL0		Partial end address (0, 1, 2, 3, , P)
	1	↑	1	-	PEL15	PEL14	PEL13	PEL12	PEL11	PEL10	PEL9	PEL8		Partial end address (0, 1, 2, 3, , P)
VSCRDEF	0	↑	1	-	0	0	1	1	0	0	1	1	(33h)	Vertical scrolling definition
	1	↑	1	-	TFA15	TFA14	TFA13	TFA12	TFA11	TFA10	TFA9	TFA8		
	1	↑	1	-	TFA7	TFA6	TFA5	TFA4	TFA3	TFA2	TFA1	TFA0		
	1	↑	1	-	VSA15	VSA14	VSA13	VSA12	VSA11	VSA10	VSA9	VSA8		
	1	↑	1	-	VSA7	VSA6	VSA5	VSA4	VSA3	VSA2	VSA1	VSA0		
	1	↑	1	-	BFA15	BFA14	BFA13	BFA12	BFA11	BFA10	BFA9	BFA8		
1	↑	1	-	BFA7	BFA6	BFA5	BFA4	BFA3	BFA2	BFA1	BFA0			
TEOFF	0	↑	1	-	0	0	1	1	0	1	0	0	(34h)	Tearing effect line off
TEON	0	↑	1	-	0	0	1	1	0	1	0	1	(35h)	Tearing effect line on

COMMAND Table 1														
Instruction	D/CX	WRX	RDX	D17-8	D7	D6	D5	D4	D3	D2	D1	D0	Hex	Function
	1	↑	1	-	-	-	-	-	-	-	-	-	TEM	
MADCTL	0	↑	1	-	0	0	1	1	0	1	1	0	(36h)	Memory data access control
	1	↑	1	-	MY	MX	MV	ML	RGB	MH	0	0		-
VSCRSADD	0	↑	1	-	0	0	1	1	0	1	1	1	(37h)	Vertical scrolling start address
	1	↑	1	-	VSP15	VSP14	VSP13	VSP12	VSP11	VSP10	VSP9	VSP8		
	1	↑	1	-	VSP7	VSP6	VSP5	VSP4	VSP3	VSP2	VSP1	VSP0		
IDMOFF	0	↑	1	-	0	0	1	1	1	0	0	0	(38h)	Idle mode off
IDMON	0	↑	1	-	0	0	1	1	1	0	0	1	(39h)	Idle mode on
Interface Pixel Format	0	↑	1	-	0	0	1	1	1	0	1	0	(3Ah)	Interface pixel format
	1	↑	1	-	R3	R2	R1	R0	0	D2	D1	D0		Interface format
RAMWRC	0	↑	1	-	0	0	1	1	1	1	0	0	(3Ch)	Memory write continue
	1	↑	1	-	D17	D16	D15	D14	D13	D12	D11	D10		
	1	↑	1	-	Dx7	Dx6	Dx5	Dx4	Dx3	Dx2	Dx1	Dx0		
	1	↑	1	-	Dn7	Dn6	Dn5	Dn4	Dn3	Dn2	Dn1	Dn0		
RAMRDC	0	↑	1	-	0	0	1	1	1	1	1	0	(3Eh)	Memory read continue
	1	1	↑	-	-	-	-	-	-	-	-	-		Dummy Read
	1	1	↑	-	D17	D16	D15	D14	D13	D12	D11	D10		
	1	1	↑	-	Dx7	Dx6	Dx5	Dx4	Dx3	Dx2	Dx1	Dx0		
	1	1	↑	-	Dn7	Dn6	Dn5	Dn4	Dn3	Dn2	Dn1	Dn0		
TESCAN	0	↑	1	-	0	1	0	0	0	1	0	0	(44h)	Set tear scanline
	1	↑	1	-	N15	N14	N13	N12	N11	N10	N9	N8		
	1	↑	1	-	N7	N6	N5	N4	N3	N2	N1	N0		
RDTESCAN	0	↑	1	-	0	1	0	0	0	1	0	1	(45h)	Get scanline
	1	1	↑	-	-	-	-	-	-	-	-	-		Dummy Read
	1	1	↑	-	N15	N14	N13	N12	N11	N10	N9	N8		
	1	1	↑	-	N7	N6	N5	N4	N3	N2	N1	N0		

COMMAND Table 1														
Instruction	D/CX	WRX	RDX	D17-8	D7	D6	D5	D4	D3	D2	D1	D0	Hex	Function
WRDISBV	0	↑	1	-	0	1	0	1	0	0	0	1	(51h)	Write display brightness
	1	↑	1	-	DBV7	DBV6	DBV5	DBV4	DBV3	DBV2	DBV1	DBV0		
RDISBV	0	↑	1	-	0	1	0	1	0	0	1	0	(52h)	Read display brightness value
	1	1	↑	-	-	-	-	-	-	-	-	-		Dummy read
	1	1	↑	-	DBV7	DBV6	DBV5	DBV4	DBV3	DBV2	DBV1	DBV0		
WRCTRLD	0	↑	1	-	0	1	0	1	0	0	1	1	(53h)	Write CTRL display
	1	↑	1	-	0	0	BCTRL	0	DD	BL	0	0		
RDCTRLD	0	↑	1	-	0	1	0	1	0	1	0	0	(54h)	Read CTRL value display
	1	1	↑	-	-	-	-	-	-	-	-	-		Dummy read
	1	1	↑	-	0	0	BCTRL	0	DD	BL	0	0		
WRCABC	0	↑	1	-	0	1	0	1	0	1	0	1	(55h)	Write content adaptive brightness control
	1	↑	1	-	CECTRL	0	CE1	CE0	0	0	C1	C0		
RDCABC	0	↑	1	-	0	1	0	1	0	1	1	0	(56h)	Read content adaptive brightness control
	1	1	↑	-	-	-	-	-	-	-	-	-		Dummy read
	1	1	↑	-	0	0	0	0	0	0	C1	C0		
WRCABCMB	0	↑	1	-	0	1	0	1	1	1	1	0	(5Eh)	Write CABC minimum brightness
	1	↑	1	-	CMB7	CMB6	CMB5	CMB4	CMB3	CMB2	CMB1	CMB0		
RDCABCMB	0	↑	1	-	0	1	0	1	1	1	1	1	(5Fh)	Read CABC minimum brightness
	1	1	↑	-	-	-	-	-	-	-	-	-		Dummy read
	1	1	↑	-	CMB7	CMB6	CMB5	CMB4	CMB3	CMB2	CMB1	CMB0		

COMMAND Table 1														
Instruction	D/CX	WRX	RDX	D17-8	D7	D6	D5	D4	D3	D2	D1	D0	Hex	Function
RDFCHKSUM	0	↑	1		1	0	1	0	1	0	1	0	(Aah)	Read First Checksum
	1	1	↑		-	-	-	-	-	-	-	-		Dummy read
	1	1	↑		FCS7	FCS6	FCS5	FCS4	FCS3	FCS2	FCS1	FCS0		
RDCCHKSUM	0	↑	1		1	0	1	0	1	0	1	0	(Afh)	Read Continue Checksum
	1	1	↑		-	-	-	-	-	-	-	-		Dummy read
	1	1	↑		CCS7	CCS6	CCS5	CCS4	CCS3	CCS2	CCS1	CCS0		
RDID1	0	↑	1	-	1	1	0	1	1	0	1	0	(Dah)	Read ID1
	1	1	↑	-	-	-	-	-	-	-	-	-		Dummy read
	1	1	↑	-	ID17	ID16	ID15	ID14	ID13	ID12	ID11	ID10		Read parameter
RDID2	0	↑	1	-	1	1	0	1	1	0	1	1	(DBh)	Read ID2
	1	1	↑	-	-	-	-	-	-	-	-	-		Dummy read
	1	1	↑	-	ID27	ID26	ID25	ID24	ID23	ID22	ID21	ID20		Read parameter
RDID3	0	↑	1	-	1	1	0	1	1	1	0	0	(DCh)	Read ID3
	1	1	↑	-	-	-	-	-	-	-	-	-		Dummy read
	1	1	↑	-	ID37	ID36	ID35	ID34	ID33	ID32	ID31	ID30		Read parameter

7.2 初始化方法

用户所编的显示程序, 开始必须进行初始化, 否则模块无法正常显示, 过程请参考程序

点亮液晶模块的步骤

硬件准备:
开发板 (或专门设计的主板)、单片机、电源、连接线、仿真器或程序下载器 (又名烧录器)

正确地接线
根据说明书正确地与开发板连接, 连接的线包括: 液晶模块电源线、背光电源线、IO端口 (接口)
IO端口包括: 并口时: CS、RESET、RW、E、RS、D0—D7, 串口时: CS、SCLK、SDA、RESET、RS

编写软件
背光给合适的直流电可以点亮, 但液晶屏里面没有程序, 只给电不能让液晶屏显示 (我们通常说“点亮”), 程序须另外编写, 并烧录 (下载) 到单片机里液晶模块才能工作。

7.3 并行原理图

20PIN

GND	1	VSS
VDD	2	3.3V
CS	3	CS
RS	4	RS
WR/SCL	5	WR
RD	6	RD
SDA	7	
SDO	8	
DB0	9	D0
DB1	10	D1
DB2	11	D2
DB3	12	D3
DB4	13	D4
DB5	14	D5
DB6	15	D6
DB7	16	D7
RST	17	RST
IM2/PS	18	VSS
LEDA	19	3.0V
LEDK	20	VSS

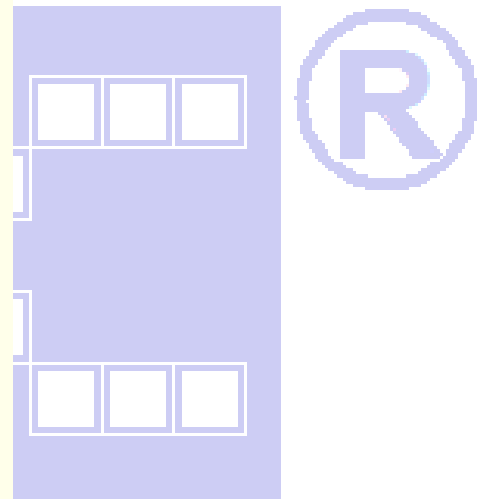

20PIN

并行接口

7.4 程序

TFT 模块与 MPU(以 8051 系列单片机为例)并口接口图如下:



图 4. 并行接口

```
//型号:JLX350-01901-BN、横屏;
```

```
//驱动 IC:ST7796S;
```

```
#include <reg51.h>
```

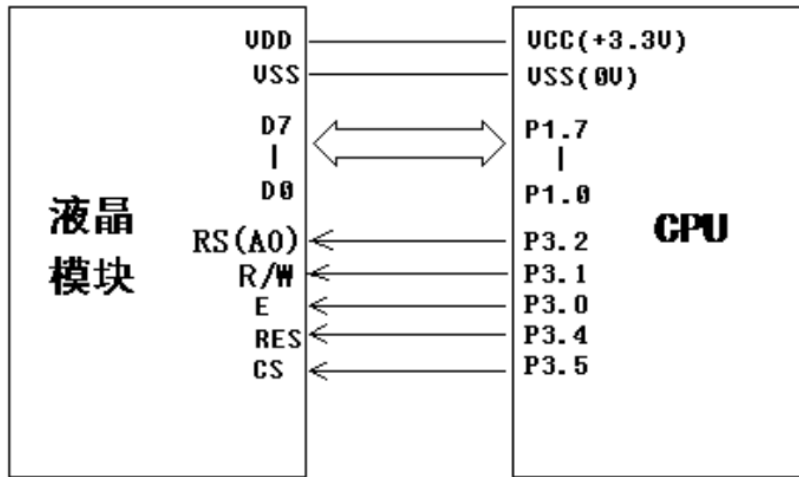
```
#include <chinese_code.h>
```

```
//液晶屏 IC 所需要的信号线的接口定义
```

```
sbit DC0=P3^2;
```

```
sbit WR0=P3^1;
```

```
sbit RD0=P3^0;
```

```
sbit CS0=P3^5;
```

```
sbit reset=P3^4;
```

```
sbit IM2=P3^6;
```

```
sbit key=P2^0;
```

```
//P2.0 口与 GND 之间接一个按键
```

```
void transfer_command(int com1)
```

```
{
```

```
    CS0 = 0;
```

```
    DC0 = 0;
```

```
    RD0 = 1;
```

```
    P1=com1;
```

```
    WR0 = 0;
```

```
    delay_us(2);
```

```
    WR0 = 1;
```

```
    CS0 = 1;
```

```
}
```

```
void transfer_data(int data1)
```

```
{
```

```
    CS0 = 0;
```

```
    DC0 = 1;
```



```

    RDO = 1;
    P1=data1;
    WRO = 0;
    WRO = 1;
    CS0 = 1;
}

```

//连写 2 个字节（即 16 位）数据到 LCD 模块

```

void transfer_data_16(uint data_16bit)
{
    transfer_data(data_16bit>>8);
    transfer_data(data_16bit);
}

```

```

void delay(long i)
{

```

```

    int j,k;
    for(j=0;j<i;j++)
        for(k=0;k<110;k++);
}

```

```

void delay_us(long i)
{

```

```

    int j,k;
    for(j=0;j<i;j++)
        for(k=0;k<1;k++);
}

```

```

void Switch()
{

```

```

    repeat:
        if (key==1) goto repeat;
        else delay(1000);
        if (key) goto repeat;
        else ;
}

```

```

void lcd_initial()
{

```

```

    reset=1;
    delay(200);
    reset=0;
    delay(200);
    reset=1;
    delay(200);
}

```

```

//***** Start Initial Sequence *****//
transfer_command(0x11); //Sleep Out
delay(200);
transfer_command(0xf0); //
transfer_data(0xc3); //enable command 2 part 1
transfer_command(0xf0);
transfer_data(0x96); //enable command 2 part 2
transfer_command(0x36); //内存数据访问控制
transfer_data(0x28); //0x28 横屏显示, 0x48 竖屏显示
    
```

```

transfer_command(0x3a); //16bit pixel
transfer_data(0x55);
    
```

```

transfer_command(0xb4);
transfer_data(0x01);
    
```

```

transfer_command(0xb7);
transfer_data(0xc6);
    
```

```

transfer_command(0xe8);
transfer_data(0x40);
transfer_data(0x8a);
transfer_data(0x00);
transfer_data(0x00);
transfer_data(0x29);
transfer_data(0x19);
transfer_data(0xa5);
transfer_data(0x33);
    
```

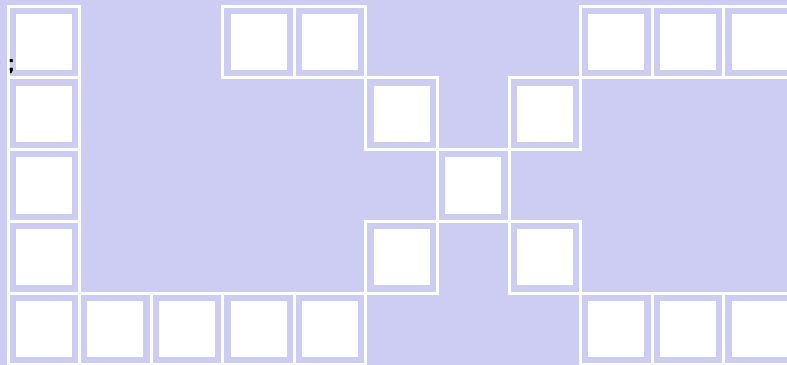

```

transfer_command(0xc1);
transfer_data(0x06);
    
```

```

transfer_command(0xc2);
transfer_data(0xa7);
    
```

```

transfer_command(0xc5);
transfer_data(0x18);
    
```

```

transfer_command(0xe0); //Positive Voltage Gamma Control
transfer_data(0xf0);
transfer_data(0x09);
transfer_data(0x0b);
transfer_data(0x06);
transfer_data(0x04);
transfer_data(0x15);
    
```

```

transfer_data(0x2f);
transfer_data(0x54);
transfer_data(0x42);
transfer_data(0x3c);
transfer_data(0x17);
transfer_data(0x14);
transfer_data(0x18);
transfer_data(0x1b);

```

```

transfer_command(0xe1); //Negative Voltage Gamma Coltrol
transfer_data(0xf0);
transfer_data(0x09);
transfer_data(0x0b);
transfer_data(0x06);
transfer_data(0x04);
transfer_data(0x03);
transfer_data(0x2d);

```

```

transfer_data(0x43);
transfer_data(0x42);
transfer_data(0x3b);
transfer_data(0x16);
transfer_data(0x14);
transfer_data(0x17);
transfer_data(0x1b);

```

```

transfer_command(0xf0);
transfer_data(0x3c);

```

```

transfer_command(0xf0);
transfer_data(0x69);
delay(120);

```

```

transfer_command(0x29); //Display ON
transfer_command(0x2c); // 写数据开始

```

```

}

```

//定义窗口坐标: 开始坐标 (XS, YS) 以及窗口大小 (x_total, y_total)

```

void lcd_address(int XS, int YS, int x_total, int y_total)

```

```

{

```

```

    int XE, YE;
    XE=XS+x_total-1;
    YE=YS+y_total-1;
    transfer_command(0x2a); // 设置 X 开始及结束的地址
    transfer_data_16(XS); // X 开始地址(16 位)
    transfer_data_16(XE); // X 结束地址(16 位)

```

```

    transfer_command(0x2b); // 设置 Y 开始及结束的地址

```



```

transfer_data_16(YS); // Y 开始地址(16 位)
transfer_data_16(YE); // Y 结束地址(16 位)

transfer_command(0x2c); // 写数据开始
}

void mono_transfer_data_16(int mono_data, int font_color, int back_color)
{
    int i;
    for(i=0; i<8; i++)
    {
        if(mono_data&0x80)
        {
            transfer_data_16(font_color); //当数据是 1 时, 显示字体颜色
        }
        else
        {
            transfer_data_16(back_color); //当数据是 0 时, 显示底色
        }
        mono_data<<=1;
    }
}

//显示 8x16 点阵的字符串
/*
void disp_string_8x16(int x, int y, char *text, int font_color, int back_color)
{
    int i=0, j, k;
    while(text[i]>0x00)
    {
        if((text[i]>=0x20)&&(text[i]<=0x7e))
        {
            j=text[i]-0x20;
            lcd_address(x, y, 8, 16);
            for(k=0; k<16; k++)
            {
                mono_transfer_data_16(ascii_table_8x16[j*16+k], font_color, back_color);
                //?a?"ascii_table_8x16[]"?"a??ÿ×é?ú"ASCII_TABLE_5X8_8X16_horizontal.h"ò?
            }
            x+=8;
            i++;
        }
        else
            i++;
    }
}

```



```
*/
```

```
//显示 16x32 点阵的字符串
```

```
void disp_string_16x32(int x,int y,char *text,int font_color,int back_color)
```

```
{
    int i=0,j,k;
    while(text[i]>0x00)
    {
        if((text[i]>=0x20)&&(text[i]<=0x7e))
        {
            j=text[i]-0x20;
            lcd_address(x,y,16,32);
            for(k=0;k<64;k++)
            {
                mono_transfer_data_16(ascii_table_16x32[j*64+k],font_color,back_color);
                //?a??"ascii_table_8x16[]"?a??ÿ×é?ú"ASCII_TABLE_5X8_8X16_horizontal.h"ä?
```

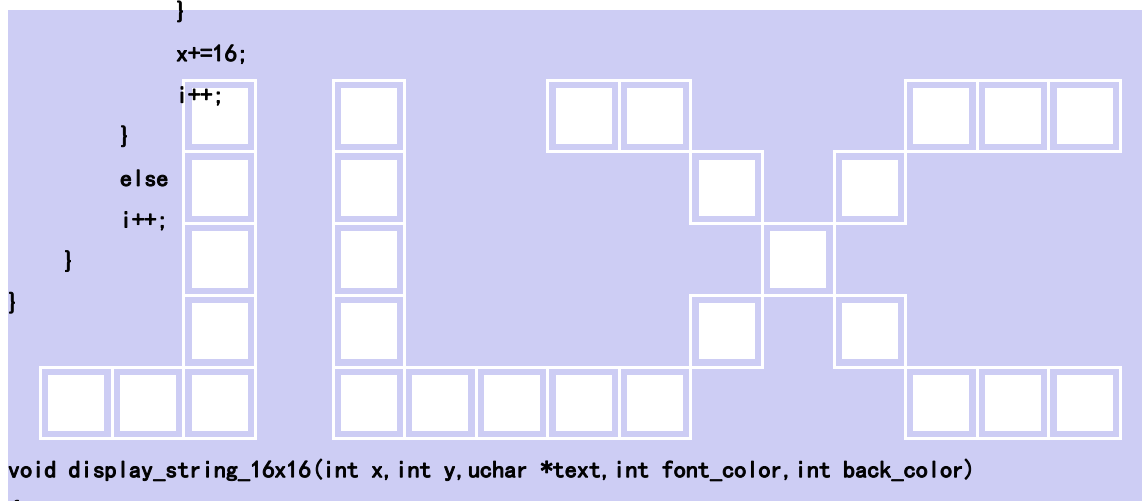

```
void display_string_16x16(int x,int y,uchar *text,int font_color,int back_color)
```

```
{
    uchar i,j,k;
    uint address;
    j = 0;
    while(text[j] != '\0') //'\0' 字符串结束标志
    {
        i = 0;
        address = 1;
        while(Chinese_horizontal_text_16x16[i] > 0x7e) // >0x7f 即说明不是 ASCII 码字符
        {
            if(Chinese_horizontal_text_16x16[i] == text[j])
            {
                if(Chinese_horizontal_text_16x16[i + 1] == text[j + 1])
                {
                    address = i * 16;
                    break;
                }
            }
        }
    }
}
```

```

        }
        i += 2;
    }
    if(y > 480)
    {
        y=0;
        x+=16;
    }

    if(address != 1)// 显示汉字
    {
        lcd_address(x, y, 16, 16);
        for(i=0;i<2;i++)
        {
            for(k = 0; k <16; k++)
            {
                mono_transfer_data_16(Chinese_horizontal_code_16x16[address], font_color, back_color);
                address++;
            }
            j+=2;
        }
        else //显示空白字符
        {
            lcd_address(x, y, 16, 16);
            for(i = 0; i <2; i++)
            {
                for(k = 0; k < 16; k++)
                {
                    mono_transfer_data_16(0x00, font_color, back_color);
                }
            }
            j+=2;
        }
        x=x+16;
    }
}

```



```

void display_string_32x32(int x,int y,uchar *text, int font_color, int back_color)
{
    uchar i, j, k;
    uint address;
    j = 0;
    while(text[j] != '\0') //'\0' 字符串结束标志
    {

```

```

i = 0;
address = 1;
while(Chinese_horizontal_text_32x32[i] > 0x7e) // >0x7f 即说明不是 ASCII 码字符
{
    if(Chinese_horizontal_text_32x32[i] == text[j])
    {
        if(Chinese_horizontal_text_32x32[i + 1] == text[j + 1])
        {
            address = i * 64;
            break;
        }
    }
    i += 2;
}

```

```

if(address != 1) // 显示汉字
{

```

```

    lcd_address(x, y, 32, 32);
    for(i=0; i<4; i++)
    {
        for(k = 0; k <32; k++)
        {
            mono_transfer_data_16(Chinese_horizontal_code_32x32[address], font_color, back_color);
            address++;
        }
        j+=2;
    }
    else //显示空白字符
    {

```

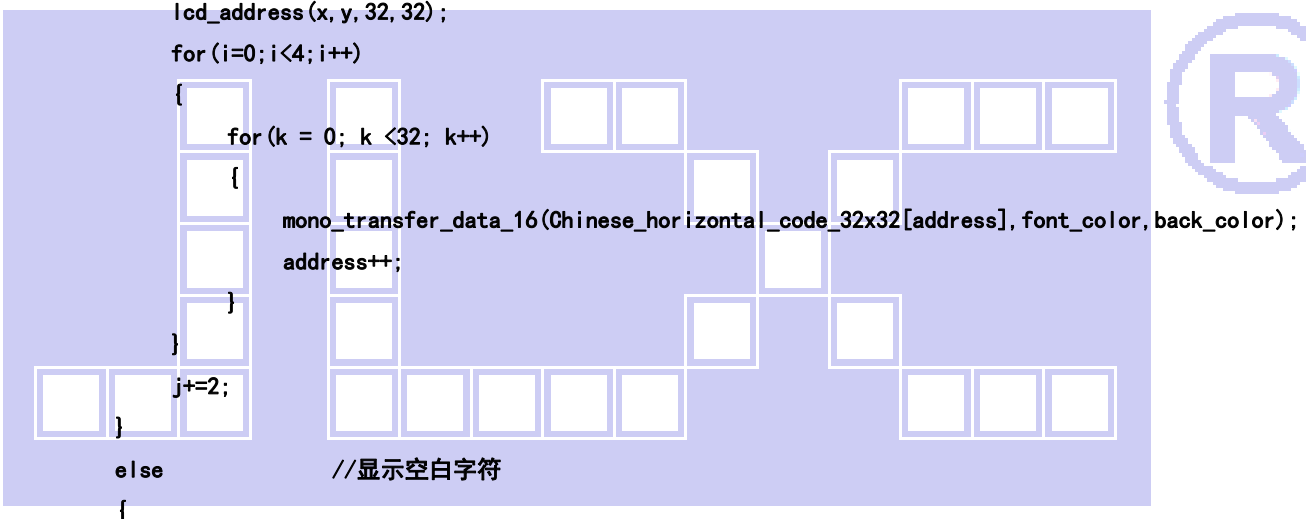

```

        lcd_address(x, y, 32, 32);
        for(i = 0; i <4; i++)
        {
            for(k = 0; k < 32; k++)
            {
                mono_transfer_data_16(0x00, font_color, back_color);
            }
        }
        j+=2;
    }
    x=x+32;
}
}

```

```

void display_black(void)
{
    int i, j, k;
    transfer_command(0x2c);        // 写数据开始
    for(i=0; i<480; i++)
    {
        transfer_data_16(0xffff);
    }
    for(i=0; i<318; i++)
    {
        for(k=0; k<1; k++)
        {
            transfer_data_16(0xffff);
        }
        for(j=0; j<478; j++)
        {
            transfer_data_16(0x0000);
        }
    }

```

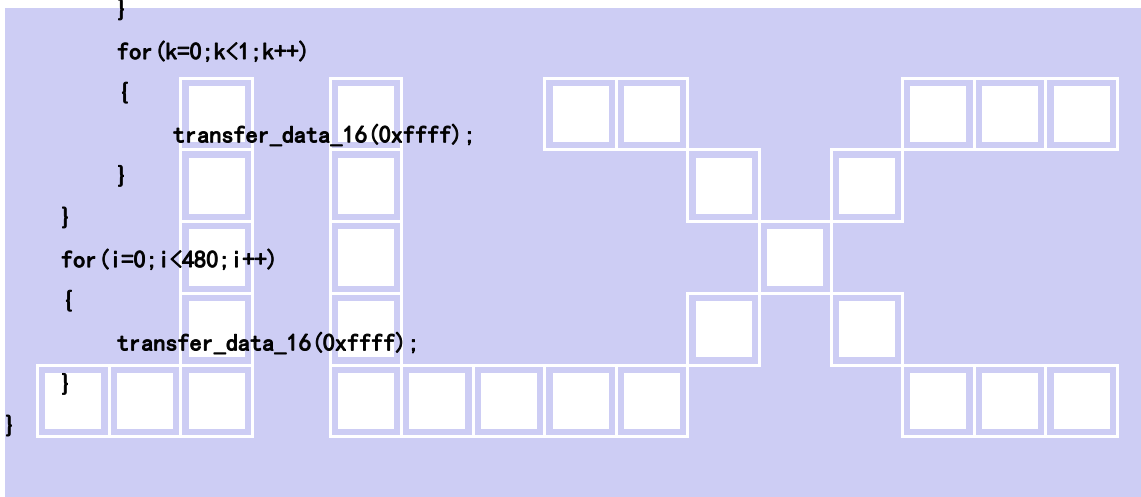

//显示一幅彩图

```

void display_image(int x, int y, uchar *dp)
{
    uchar i, j, k=0;
    lcd_address(x, y, 160, 160);
    for(i=0; i<160; i++)
    {
        for(j=0; j<160; j++)
        {
            transfer_data(*dp);        //传一个像素的图片数据的高位
            dp++;
            transfer_data(*dp);        //传一个像素的图片数据的低位
            dp++;
        }
    }
}

```

//全屏显示 RGB 颜色

```
void display_RGB(void)
{
    int i, j;
    lcd_address(0, 0, 480, 320);
    for(i=0; i<160; i++)
    {
        for(j=0; j<320; j++)
        {
            transfer_data_16(red);
        }
    }

    for(i=0; i<160; i++)
    {
        for(j=0; j<320; j++)
        {
            transfer_data_16(green);
        }
    }

    for(i=0; i<160; i++)
    {
        for(j=0; j<320; j++)
        {
            transfer_data_16(blue);
        }
    }
}
```

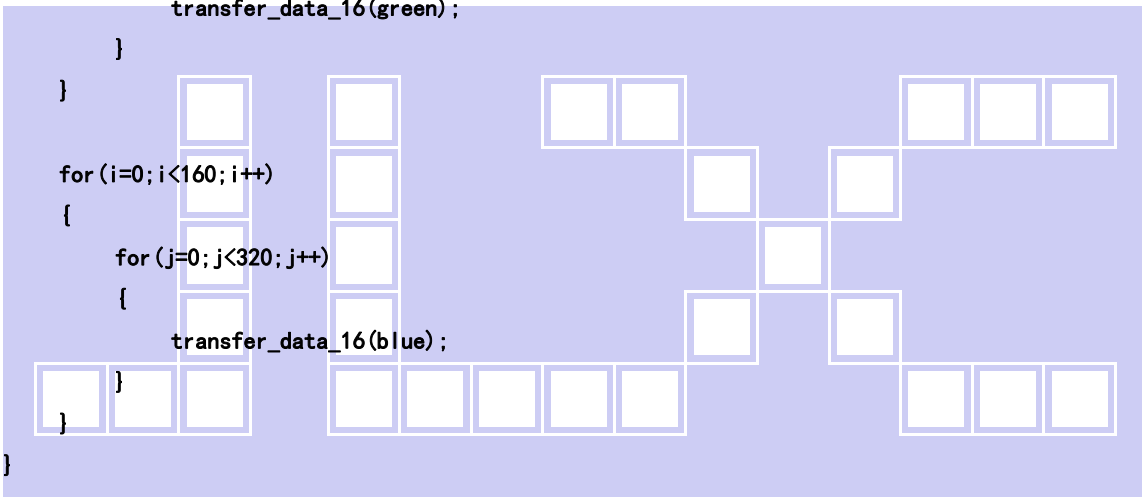

函数名: Gray16

功能: 显示 16 灰阶

*****/

```
void display_Gray16(void)    //color: WHITE, RED, GREEN, BLUE
{
    uint dataa;
    uint i, j, k;

    for(i = 0; i < 320; i++)
    {
        for(j = 0; j < 16; j++)
        {
            dataa = ((2 * j) << 11) | ((4 * j) << 5) | (2 * j);
            for(k = 0; k < 480 / 16; k++)
            {
```

```

        transfer_data_16(dataaa);
    }
}
}
}

```

//全屏显示一种颜色

```
void display_color(uint color_data)
```

```

{
    int i, j;
    lcd_address(0, 0, 480, 320);
    for (i=0; i<480; i++)
    {
        for (j=0; j<320; j++)
        {
            transfer_data_16(color_data);
        }
    }
}

```

```
void main(void)
```

```

{
    IM2=0;
    lcd_initial();
    while(1)
    {
        display_color(0x001f);
        display_string_32x32(48, 16, "深圳市晶联讯电子有限公司", white, blue);
        display_string_32x32(120, 64, "型号", white, blue);
        display_string_32x32(120, 112, "视窗", white, blue);
        display_string_32x32(120, 160, "驱动", white, blue);
        disp_string_16x32(184, 64, ": JLX350-01901", white, blue);
        disp_string_16x32(184, 112, "48. 9x73. 4mm", white, blue);
        disp_string_16x32(184, 160, "IC: ST7789S", white, blue);

        display_string_16x16(40, 208, "经营宗旨: 制造高品质产品及提供良好服务", white, blue);
        display_string_16x16(40, 240, "质量方针: 客户至上, 质量第一, 持续改进, 服务到位", white, blue);
        display_string_16x16(40, 272, "经营目标: 做最好的液晶模块厂家, 做客户信得过的企业", white, blue);
        Switch();
    }
}
// display_image(0, 0, pic1);
// display_image(160, 0, pic1);
// display_image(320, 0, pic1);
// display_image(0, 160, pic1);

```



```

//      display_image(160, 160, pic1);
//      display_image(320, 160, pic1);
//      Switch();
//      display_RGB();
//      Switch();
//      display_Gray16();
//      Switch();
//      display_color(0xf800);
//      Switch();
//      display_color(0x07e0);
//      Switch();
//      display_color(0x001f);
//      Switch();
//      display_black();
//      Switch();
//      display_color(0xffff);
//      Switch();
}
}

```

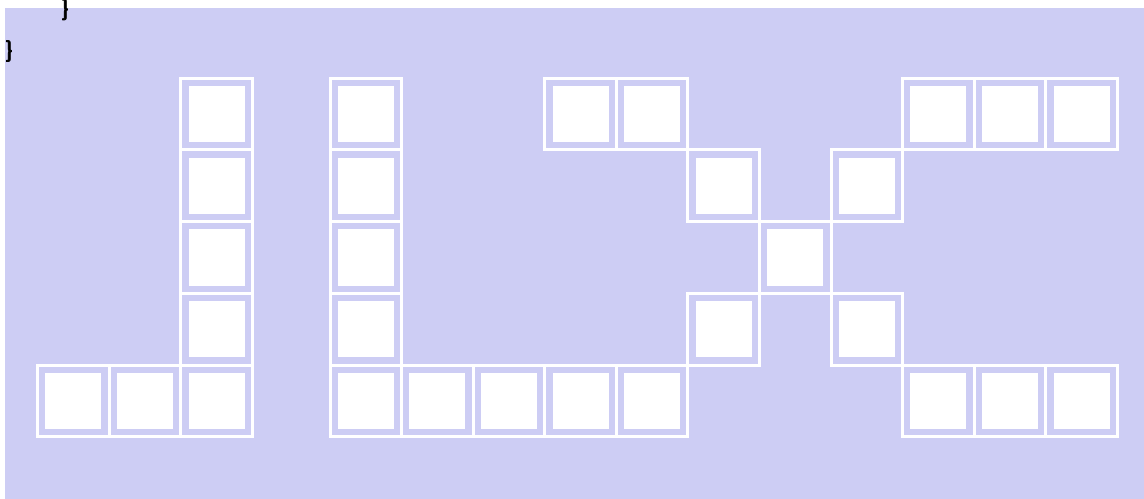

7.5 串行原理图

20PIN

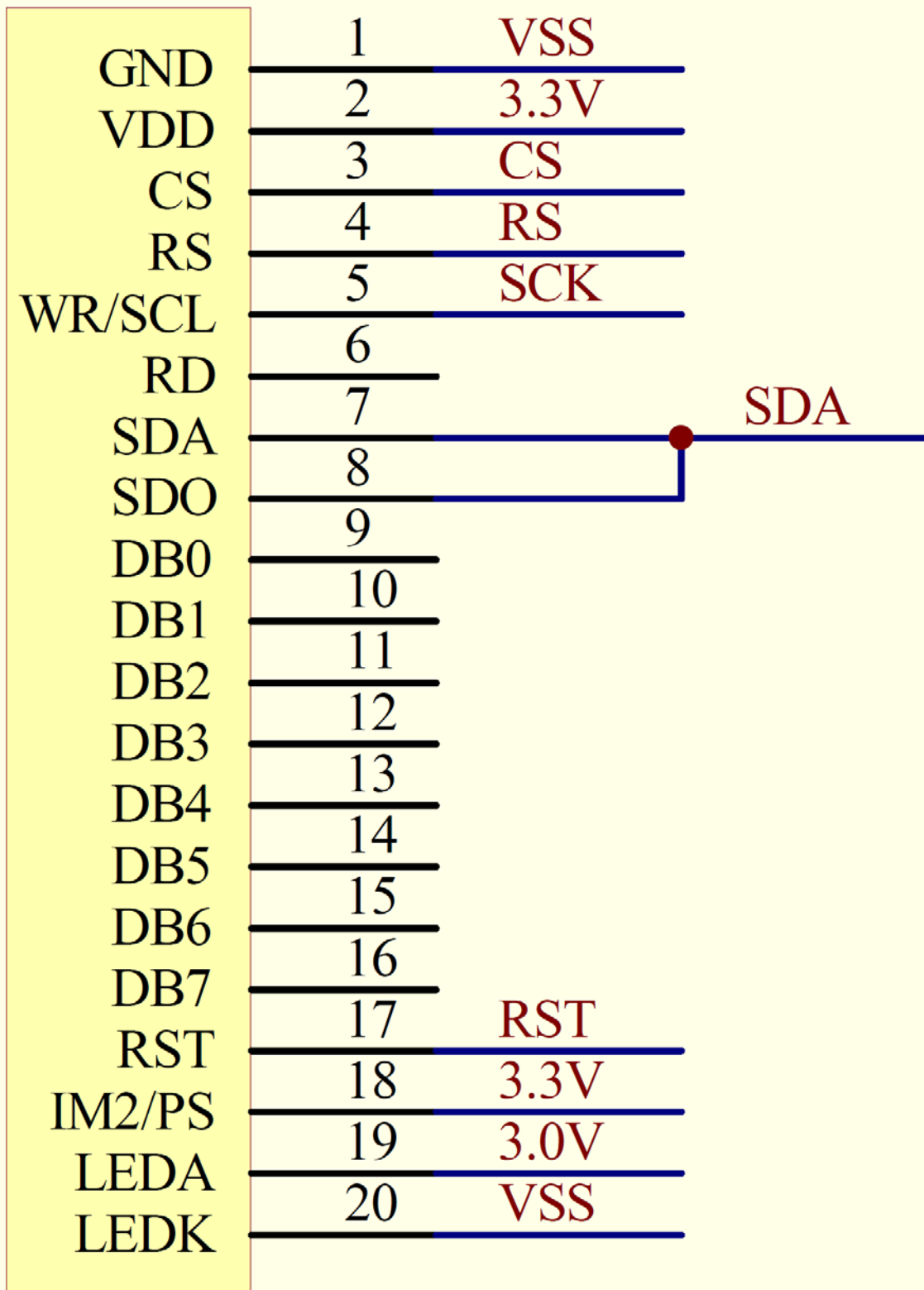

20PIN

串行接口

7.6 程序

TFT 模块与 MPU(以 8051 系列单片机为例) 串行接口图如下:

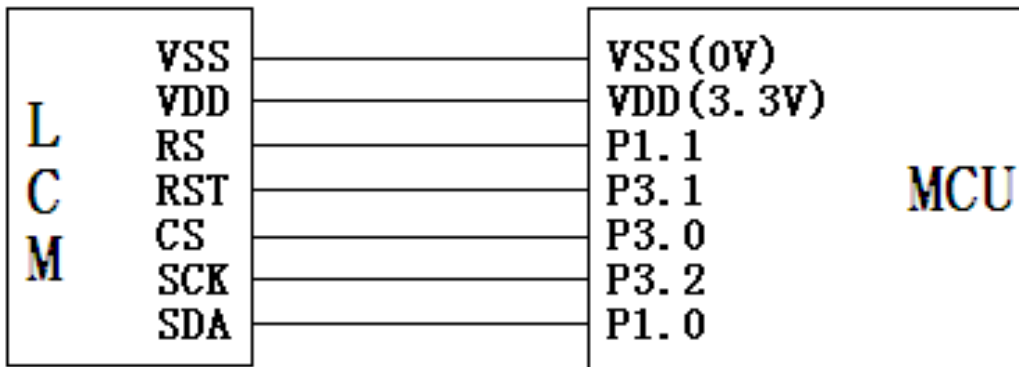

与并行方式相比较, 只需改变接口顺序以及传送数据、传送命令这两个函数即可:
串程序序:

```
//型号:JLX350-01901-BN、横屏;
```

```
//驱动 IC:ST7796S;
```

```
#include <STC15F2K60S2.H>
```

```
#include <chinese_code.h>
```

```
//液晶屏 IC 所需要的信号线的接口定义
```

```
sbit RS=P1^1;
```

```
sbit SCK=P3^2;
```

```
sbit SDA=P1^0;
```

```
sbit CS=P3^0;
```

```
sbit RST=P3^1;
```

```
sbit IM2=P3^6;
```

```
sbit key=P2^0; //P2.0 口与 GND 之间接一个按键
```

```
void transfer_command(int com1)
```

```
{
```

```
    char i;
```

```
    CS=0;
```

```
    RS=0;
```

```
    for(i=0;i<8;i++)
```

```
    {
```

```
        SCK=0;
```

```
        if(com1&0x80) SDA=1;
```

```
        else SDA=0;
```

```
        SCK=1;
```

```
        com1=com1<<=1;
```

```
    }
```

```
}
```

```

void transfer_data(int data1)
{
    char i;
    CS=0;
    RS=1;
    for (i=0; i<8; i++)
    {
        SCK=0;
        if (data1&0x80) SDA=1;
        else SDA=0;
        SCK=1;
        data1=data1<<=1;
    }
}

```

