

JLX240-00301-BN 使用说明书

(插接式 FPC)

目 录

序号	内 容 标 题	页 码
1	概述	2
2	特点	2
3	外形及接口引脚功能	3~4
4	基本原理	4
5	技术参数	4~5
6	时序特性	5~6
7	指令功能及硬件接口与编程案例	7~末页

1. 概述

晶联讯电子专注于液晶屏及液晶模块的研发、制造。所生产 JLX240-00301 型 TFT 模块由于使用方便、显示清晰，广泛应用于各种人机交流面板。

JLX240-00301 可以显示 320 列*240 行点阵彩色图片，或显示 20 个/行*15 行 16*16 点阵的汉字，或显示 40 个/行*30 行 8*8 点阵的英文、数字、符号。

2. JLX240-00301 图像型点阵 TFT 模块的特性

2.1 结构轻、薄、带背光。

2.2 IC 采用 ST7789V, 功能强大，稳定性好

2.3 显示内容：

- 320*240 点阵彩色图片；

- 可选用 32*32 点阵或其他点阵的图片来自编汉字，按照 32*32 点阵汉字来计算可显示 10 个字/行*7 行。

- 可选用 16*16 点阵或其他点阵的图片来自编汉字，按照 16*16 点阵汉字来计算可显示 20 个字/行*15 行。

2.4 指令功能强：例如可以用指令控制显示内容顺时针旋转 90°、逆时针旋转 90° 或倒立竖放。

2.5 接口方式：并口方式。

2.6 工作温度宽：-20℃ - +70℃；

2.7 工作温度宽：-30℃ - +80℃；

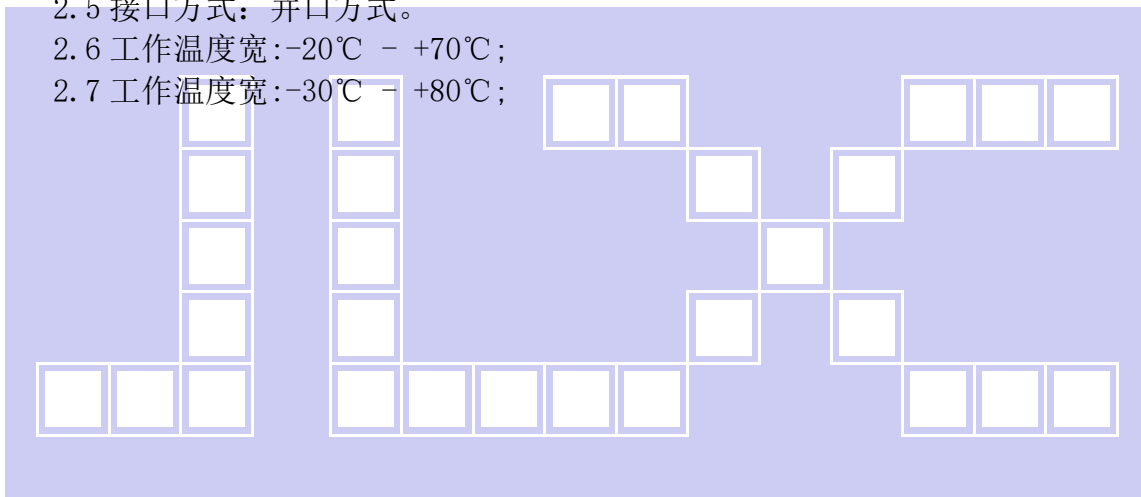

3. 外形尺寸及接口引脚功能

引脚定义:

No.	PIN NAME
1	GND
2	VDD
3	D7
4	D6
5	D5
6	D4
7	D3
8	D2
9	D1
10	D0
11	SDA
12	RD
13	WR
14	DC
15	CS
16	RST
17	IMI
18	IM2
19	LEDA
20	LEDK

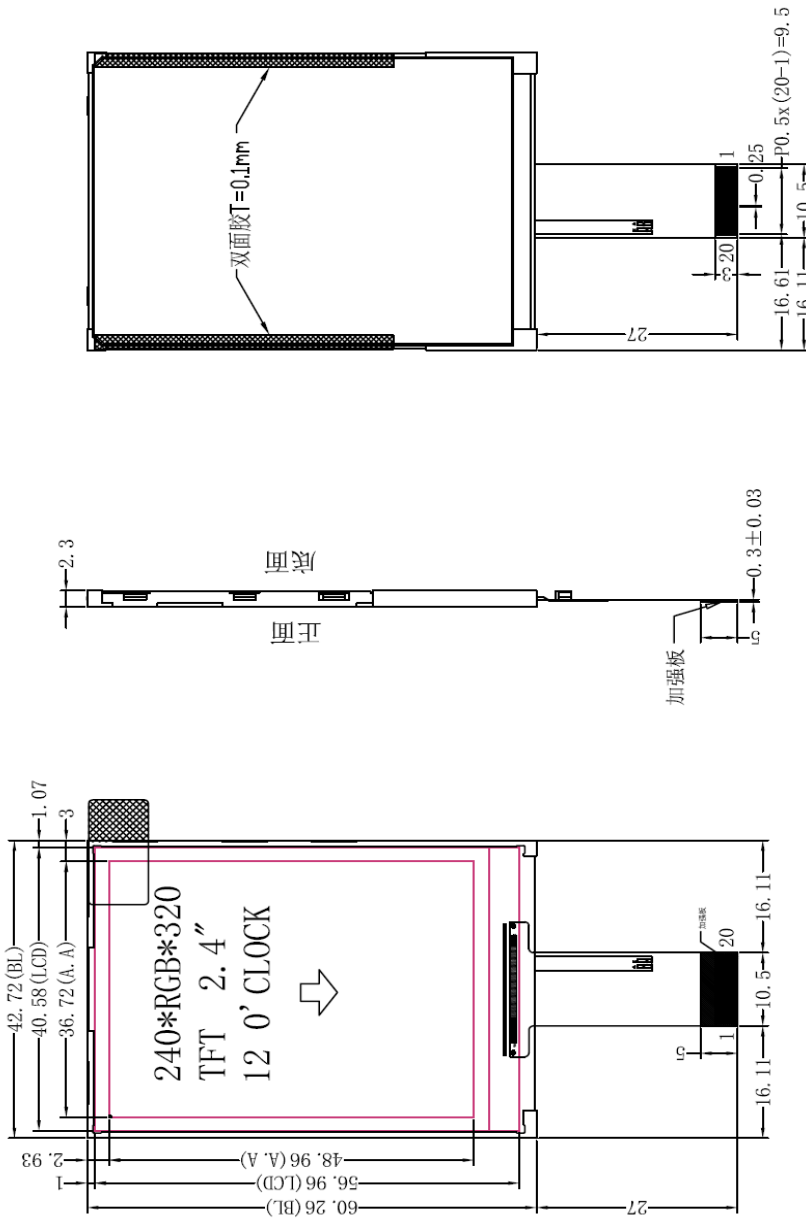

1. LED CIRCUIT DIAGRAM:

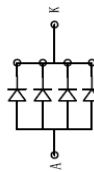

NOTES:

1. VIEWING DIRECTION : 12:00' CLOCK
2. POLARIZER MODE : TRANSMISSIVE
3. OPERATING TEMP : -20° C ~ +70° C
4. STORAGE TEMP : -30° C ~ +80° C
5. DRIVER IC : ST7789V 3.3V
6. LED VOLTAGE : 3.0V
7. GENERAL TOLERANCE : ±0.2

REVISION RECORD	DATE	APPROVED	Model No: JLX240-00301-BN	Part No: LCM	DATE	2019-07-26	GEN. TOL: ±0.2
1	FIRST	APPROVED					PEC(3)
2							VER: A
3							SHEET: 1/1
4							UNIT: mm
5							SCALE: 1/1
6							

深圳市晶联讯电子有限公司



Http://www.jlxlcd.cn

图 1. 带背光的 TFT 模块外形尺寸

模块的接口引脚功能

引线号	符号	名称	功能
1	GND	接地	0V
2	VDD	供电电源正极	供电电源正极
3	D7	I/O	数据总线 DB7
4	D6	I/O	数据总线 DB6
5	D5	I/O	数据总线 DB5
6	D4	I/O	数据总线 DB4
7	D3	I/O	数据总线 DB3
8	D2	I/O	数据总线 DB2
9	D1	I/O	数据总线 DB1
10	D0	I/O	数据总线 DB0
11	SDA	串行数据	串行数据
12	E(/RD)	读	读功能
13	R/W(/WR)	写	并口:写功能;串口:做为 RS 功能使用
14	DC(RS)	寄存器选择信号	并口: H:数据寄存器 L:指令寄存器;串口:串行时钟 SCK
15	CS	片选	低电平片选
16	RST	复位	低电平复位, 复位完成后, 回到高电平, TFT 模块开始工作
17	IM1	IM1	IM1=0 选择并口, IM1=1 选择串口
18	IM2	IM2	IM2=0 选择并口, IM2=1 选择串口
19	LEDA	背光电源正极	接 3.0V (接 3.3V 串 10 欧电阻, 接 5.0V 串 51 欧电阻)
20	LEDK	背光电源负极	接 VSS

表 1: 模块的接口引脚功能

4. 基本原理

4.1 TFT 屏 (LCD)

在 LCD 上排列着 320×240 点阵, 320 个列信号与驱动 IC 相连, 240 个行信号也与驱动 IC 相连, IC 绑定在 LCD 玻璃上 (这种加工工艺叫 COG)。

4.2 背光参数

该型号 TFT 模块带 LED 背光源。它的性能参数如下:

工作温度: -20~+70° C;

存储温度: -30~+80° C;

背光板是白色。

正常工作电流为: 32~80mA (LED 灯数共 4 颗, 每颗灯是 10~20 mA)

工作电压: 3.0V (接 3.3V 串 10 欧电阻, 接 5.0V 串 51 欧电阻)

5. 技术参数

5.1 最大极限参数 (超过极限参数则会损坏 TFT 模块)

名称	符号	标准值			单位
		最小	典型	最大	
电路电源	VDD - VSS	-0.3	3.0	3.3	V
工作温度		-20		+70	°C

储存温度		-30		+80	°C
------	--	-----	--	-----	----

表 2: 最大极限参数

5.2 直流 (DC) 参数

名称	符号	测试条件	标准值			单位
			MIN	TYPE	MAX	
工作电压	VDD		2.4	-	3.3	V
背光工作电压	VLED		2.9	3.0	3.1	V
输入高电平	V _{IHC}	-	0.8xVDD	-	VDD	V
输入低电平	V _{ILC}	-	VSS	-	0.2xVDD	V
输出高电平	V _{OHC}	I _{OH} = -0.5mA	0.8xVDD	-	VDD	V
输出低电平	V _{OHC}	I _{OL} = -0.5mA	VSS	-	0.2xVDD	V
模块工作电流	I _{DD}	VDD = 3.3V	-		0.3	mA
背光工作电流	I _{LED}	V _{LED} =3.0V	32	60	80	mA

表 3: 直流 (DC) 参数

6. 读写时序特性



图 2. 8080 时序图

6.1 时序要求 (AC 参数):

表 4.

项目	符号	测试条件	极限值			单位
			MIN	TYPE	MAX	
地址保持时间	A0	T _{AHt}	10	—	—	
地址建立时间		T _{ASt}	0	—	—	
芯片选择“高”脉冲宽度		T _{CHW}	0			

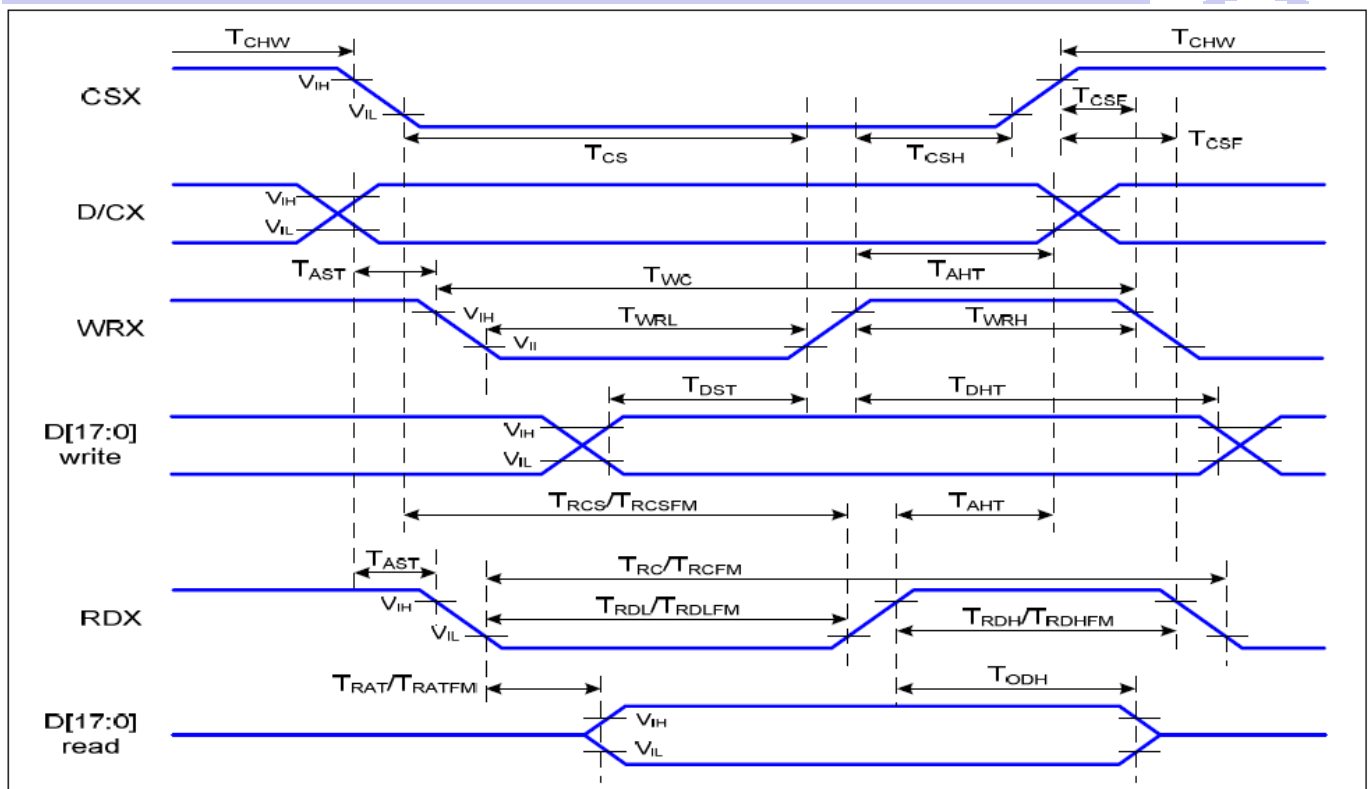
芯片选择建立时间 (写)	CS	T_{CS}	15		ns
芯片选择建立时间 (读)		T_{RCS}	45		
芯片选择保持时间	WR	T_{CSH}	10		
写周期		T_{WC}	66		
控制脉冲“高”持续时间		T_{WRH}	15		
控制脉冲“低”持续时间		T_{WRL}	15		
芯片选择保持时间	RD	T_{CSH}	10		
读周期		T_{RC}	160		
控制脉冲“高”持续时间		T_{RDH}	90		
控制脉冲“低”持续时间		T_{RDL}	45		
数据建立时间	D7-D0	T_{DST}	10		
数据保持时间		T_{DHT}	10		
读取时间		T_{RAT}		40	
输出禁用时间		T_{ODH}	20	80	

VDD=3.3V $T_a=25^\circ\text{C}$

6.2 电源启动后复位的时序要求 (RESET CONDITION AFTER POWER UP):



图 3: 电源启动后复位的时序

表 5: 电源启动后复位的时序要求

VDD=3.3V, $T_a = 25^\circ\text{C}$

项目	符号	测试条件	极限值			单位
			MIN	TYPE	MAX	
复位时间	t_R		--	--	120	ms
复位保持低电平的时间	t_{RW}	引脚: RES	10	--	--	us

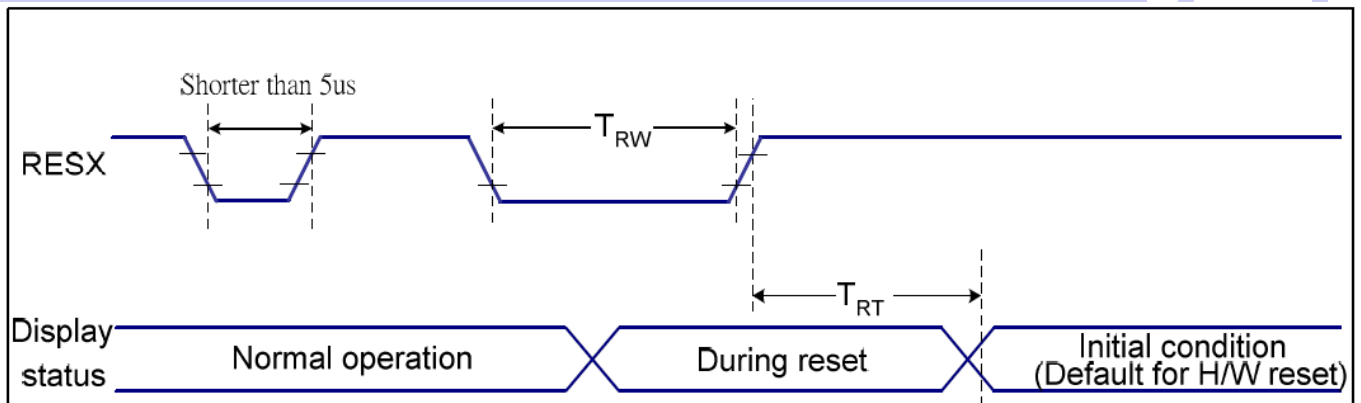
7. 指令功能:

7.1 指令表

Instruction	D/CX	WRX	RDX	D17-8	D7	D6	D5	D4	D3	D2	D1	D0	Hex	Function
NOP	0	↑	1	-	0	0	0	0	0	0	0	0	(00h)	No operation
SWRESET	0	↑	1	-	0	0	0	0	0	0	0	1	(01h)	Software reset
RDDID	0	↑	1	-	0	0	0	0	0	1	0	0	(04h)	Read display ID
	1	1	↑	-	-	-	-	-	-	-	-	-		Dummy read
	1	1	↑	-	ID17	ID16	ID15	ID14	ID13	ID12	ID11	ID10		ID1 read
	1	1	↑	-	ID27	ID26	ID25	ID24	ID23	ID22	ID21	ID20		ID2 read
	1	1	↑	-	ID37	ID36	ID35	ID34	ID33	ID32	ID31	ID30		ID3 read
RDDST	0	↑	1	-	0	0	0	0	1	0	0	1	(09h)	Read display status
	1	1	↑	-	-	-	-	-	-	-	-	-		Dummy read
	1	1	↑	-	BSTON	MY	MX	MV	ML	RGB	MH	ST24		-
	1	1	↑	-	ST23	IFPF2	IFPF1	IFPF0	IDMON	PTLON	SLOUT	NORON		-
	1	1	↑	-	ST15	ST14	INVON	ST12	ST11	DISON	TEON	GCS2		-
	1	1	↑	-	GCS1	GCS0	TEM	ST4	ST3	ST2	ST1	ST0		-
RDDPM	0	↑	1	-	0	0	0	0	1	0	1	0	(0Ah)	Read display power
	1	1	↑	-	-	-	-	-	-	-	-	-		Dummy read
	1	1	↑	-	BSTON	IDMON	PTLON	SLPOUT	NORON	DISON	0	0		
RDMADCTL	0	↑	1	-	0	0	0	0	1	0	1	1	(0Bh)	Read display
	1	1	↑	-	-	-	-	-	-	-	-	-		Dummy read
	1	1	↑	-	MY	MX	MV	ML	RGB	MH	0	0		-
RDCOLMOD	0	↑	1	-	0	0	0	0	1	1	0	0	(0Ch)	Read display pixel
	1	1	↑	-	-	-	-	-	-	-	-	-		Dummy read
	1	1	↑	-	0	D6	D5	D4	0	D2	D1	D0		-
RDDIM	0	↑	1	-	0	0	0	0	1	1	0	1	(0Dh)	Read display image
	1	1	↑	-	-	-	-	-	-	-	-	-		Dummy read
	1	1	↑	-	VSSON	0	INVON	0	0	GC2	GC1	GC0		-
RDDSM	0	↑	1	-	0	0	0	0	1	1	1	0	(0Eh)	Read display signal
	1	1	↑	-	-	-	-	-	-	-	-	-		Dummy read

Instruction	D/CX	WRX	RDX	D17-8	D7	D6	D5	D4	D3	D2	D1	D0	Hex	Function
	1	1	↑	-	TEON	TEM	0	0	0	0	0	0		-
RDDSDR	0	↑	1	-	0	0	0	0	1	1	1	1	(0Fh)	Read display self-diagnostic result
	1	1	↑	-	-	-	-	-	-	-	-	-		Dummy read
	1	1	↑	-	D7	D6	0	0	0	0	0	0		-
SLPIN	0	↑	1	-	0	0	0	1	0	0	0	0	(10h)	Sleep in
SLPOUT	0	↑	1	-	0	0	0	1	0	0	0	1	(11h)	Sleep out
PTLON	0	↑	1	-	0	0	0	1	0	0	1	0	(12h)	Partial mode on
NORON	0	↑	1	-	0	0	0	1	0	0	1	1	(13h)	Partial off (Normal)
INVOFF	0	↑	1	-	0	0	1	0	0	0	0	0	(20h)	Display inversion off
INVON	0	↑	1	-	0	0	1	0	0	0	0	1	(21h)	Display inversion on
GAMSET	0	↑	1	-	0	0	1	0	0	0	0	1	(26h)	Display inversion on
	1	↑	1	-	0	0	0	0	GC3	GC2	GC1	GC0		
DISPOFF	0	↑	1	-	0	0	1	0	1	0	0	0	(28h)	Display off
DISPON	0	↑	1	-	0	0	1	0	1	0	0	1	(29h)	Display on
CASET	0	↑	1	-	0	0	1	0	1	0	1	0	(2Ah)	Column address set
	1	↑	1	-	XS15	XS14	XS13	XS12	XS11	XS10	XS9	XS8		X address start:
	1	↑	1		XS7	XS6	XS5	XS4	XS3	XS2	XS1	XS0		$0 \leq XS \leq X$
	1	↑	1		XE15	XE14	XE13	XE12	XE11	XE10	XE9	XE8		X address start:
1	↑	1		XE7	XE6	XE5	XE4	XE3	XE2	XE1	XE0		$S \leq XE \leq X$	
RASET	0	↑	1	-	0	0	1	0	1	0	1	1	(2Bh)	Row address set
	1	↑	1	-	YS15	YS14	YS13	YS12	YS11	YS10	YS9	YS8		Y address start:
	1	↑	1		YS7	YS6	YS5	YS4	YS3	YS2	YS1	YS0		$0 \leq YS \leq Y$
	1	↑	1		YE15	YE14	YE13	YE12	YE11	YE10	YE9	YE8		Y address start:
1	↑	1		YE7	YE6	YE5	YE4	YE3	YE2	YE1	YE0		$S \leq YE \leq Y$	
RAMWR	0	↑	1	-	0	0	1	0	1	1	0	0	(2Ch)	Memory write
	1	↑	1	D1[17:8]	D1[7]	D1[6]	D1[5]	D1[4]	D1[3]	D1[2]	D1[1]	D1[0]		Write data
	1	↑	1	Dx[17:8]	Dx[7]	Dx[6]	Dx[5]	Dx[4]	Dx[3]	Dx[2]	Dx[1]	Dx[0]		
1	↑	1	Dn[17:8]	Dn[7]	Dn[6]	Dn[5]	Dn[4]	Dn[3]	Dn[2]	Dn[1]	Dn[0]			
RAMRD	0	↑	1	-	0	0	1	0	1	1	1	0	(2Eh)	Memory read

Instruction	D/CX	WRX	RDX	D17-8	D7	D6	D5	D4	D3	D2	D1	D0	Hex	Function
	1	1	↑	-	-	-	-	-	-	-	-	-		Dummy read
	1	1	↑	D1[17:8]	D1[7]	D1[6]	D1[5]	D1[4]	D1[3]	D1[2]	D1[1]	D1[0]		Read data
	1	1	↑	Dx[17:8]	Dx[7]	Dx[6]	Dx[5]	Dx[4]	Dx[3]	Dx[2]	Dx[1]	Dx[0]		
	1	1	↑	Dn[17:8]	Dn[7]	Dn[6]	Dn[5]	Dn[4]	Dn[3]	Dn[2]	Dn[1]	Dn[0]		
PTLAR	0	↑	1	-	0	0	1	1	0	0	0	0	(30h)	Partial start/end address set
	1	↑	1	-	PSL15	PSL14	PSL13	PSL12	PSL11	PSL10	PSL9	PSL8		Partial start address: (0, 1, 2, ...P)
	1	↑	1	-	PSL7	PSL6	PSL5	PSL4	PSL3	PSL2	PSL1	PSL0		
	1	↑	1	-	PEL15	PEL14	PEL13	PEL12	PEL11	PEL10	PEL9	PEL8		Partial end address (0, 1, 2, 3, ...P)
VSCRDEF	0	↑	1	-	0	0	1	1	0	0	1	1	(33h)	Vertical scrolling definition
	1	↑	1	-	TFA15	TFA14	TFA13	TFA12	TFA11	TFA10	TFA9	TFA8		
	1	↑	1	-	TFA7	TFA6	TFA5	TFA4	TFA3	TFA2	TFA1	TFA0		
	1	↑	1	-	VSA15	VSA14	VSA13	VSA12	VSA11	VSA10	VSA9	VSA8		
	1	↑	1	-	VSA7	VSA6	VSA5	VSA4	VSA3	VSA2	VSA1	VSA0		
	1	↑	1	-	BFA15	BFA14	BFA13	BFA12	BFA11	BFA10	BFA9	BFA8		
	1	↑	1	-	BFA7	BFA6	BFA5	BFA4	BFA3	BFA2	BFA1	BFA0		
TEOFF	0	↑	1	-	0	0	1	1	0	1	0	0	(34h)	Tearing effect line off
TEON	0	↑	1	-	0	0	1	1	0	1	0	1	(35h)	Tearing effect line on
	1	↑	1	-	-	-	-	-	-	-	-	TEM		
MADCTL	0	↑	1	-	0	0	1	1	0	1	1	0	(36h)	Memory data access control
	1	↑	1	-	MY	MX	MV	ML	RGB	0	0	0		-
VSCRSAADD	0	↑	1	-	0	0	1	1	0	1	1	1	(37h)	Vertical scrolling start address
	1	↑	1	-	VSP15	VSP14	VSP13	VSP12	VSP11	VSP10	VSP9	VSP8		
	1	↑	1	-	VSP7	VSP6	VSP5	VSP4	VSP3	VSP2	VSP1	VSP0		
IDMOFF	0	↑	1	-	0	0	1	1	1	0	0	0	(38h)	Idle mode off
IDMON	0	↑	1	-	0	0	1	1	1	0	0	1	(39h)	Idle mode on

Instruction	D/CX	WRX	RDX	D17-8	D7	D6	D5	D4	D3	D2	D1	D0	Hex	Function
COLMOD	0	↑	1	-	0	0	1	1	1	0	1	0	(3Ah)	Interface pixel format
	1	↑	1	-	0	D6	D5	D4	0	D2	D1	D0		Interface format
RAMWRC	0	↑	1	-	0	0	1	1	1	1	0	0	(3Ch)	Memory write continue
	1	↑	1	D1[17:8]	D1[7]	D1[6]	D1[5]	D1[4]	D1[3]	D1[2]	D1[1]	D1[0]		Write data
	1	↑	1	Dx[17:8]	Dx[7]	Dx[6]	Dx[5]	Dx[4]	Dx[3]	Dx[2]	Dx[1]	Dx[0]		
	1	↑	1	Dn[17:8]	Dn[7]	Dn[6]	Dn[5]	Dn[4]	Dn[3]	Dn[2]	Dn[1]	Dn[0]		
RAMRDC	0	↑	1	-	0	0	1	1	1	1	1	0	(3Eh)	Memory read continue
	1	1	↑	-	-	-	-	-	-	-	-	-		Dummy Read
	1	1	↑	D1[17:8]	D1[7]	D1[6]	D1[5]	D1[4]	D1[3]	D1[2]	D1[1]	D1[0]		
	1	1	↑	Dx[17:8]	Dx[7]	Dx[6]	Dx[5]	Dx[4]	Dx[3]	Dx[2]	Dx[1]	Dx[0]		
	1	1	↑	Dn[17:8]	Dn[7]	Dn[6]	Dn[5]	Dn[4]	Dn[3]	Dn[2]	Dn[1]	Dn[0]		
TESCAN	0	↑	1	-	0	1	0	0	0	1	0	0	(44h)	Set tear scanline
	1	↑	1	-	N15	N14	N13	N12	N11	N10	N9	N8		
	1	↑	1	-	N7	N6	N5	N4	N3	N2	N1	N0		
RDTESCAN	0	↑	1	-	0	1	0	0	0	1	0	1	(45h)	Get scanline
	1	1	↑	-	-	-	-	-	-	-	-	-		Dummy Read
	1	1	↑	-	-	-	-	-	-	-	N9	N8		
	1	1	↑	-	N7	N6	N5	N4	N3	N2	N1	N0		
WRDISBV	0	↑	1	-	0	1	0	1	0	0	0	1	(51h)	Write display brightness
	1	↑	1	-	DBV7	DBV6	DBV5	DBV4	DBV3	DBV2	DBV1	DBV0		
RDDISBV	0	↑	1	-	0	1	0	1	0	0	1	0	(52h)	Read display brightness value
	1	1	↑	-	-	-	-	-	-	-	-	-		Dummy read
	1	1	↑	-	DBV7	DBV6	DBV5	DBV4	DBV3	DBV2	DBV1	DBV0		
WRCTRLD	0	↑	1	-	0	1	0	1	0	0	1	1	(53h)	Write CTRL display
	1	↑	1	-	0	0	BCTRL	0	DD	BL	0	0		
RDCTRLD	0	↑	1	-	0	1	0	1	0	1	0	0	(54h)	Read CTRL value display
	1	1	↑	-	-	-	-	-	-	-	-	-		Dummy read
	1	1	↑	-	0	0	BCTRL	0	DD	BL	0	0		

Instruction	D/CX	WRX	RDX	D17-8	D7	D6	D5	D4	D3	D2	D1	D0	Hex	Function
WRCACE	0	↑	1	-	0	1	0	1	0	1	0	1	(55h)	Write content adaptive brightness control and Color enhancemnet
	1	↑	1	-	CECTRL	0	CE1	CE0	0	0	C1	C0		
RDCABC	0	↑	1	-	0	1	0	1	0	1	1	0	(56h)	Read content adaptive brightness control
	1	1	↑	-	-	-	-	-	-	-	-	-		Dummy read
	1	1	↑	-	0	CECTRL	0	0	0	0	C1	C0		
WRCABCMB	0	↑	1	-	0	1	0	1	1	1	1	0	(5Eh)	Write CABC minimum brightness
	1	↑	1	-	CMB7	CMB6	CMB5	CMB4	CMB3	CMB2	CMB1	CMB0		
RDCABCMB	0	↑	1	-	0	1	0	1	1	1	1	1	(5Fh)	Read CABC minimum brightness
	1	1	↑	-	-	-	-	-	-	-	-	-		Dummy read
	1	1	↑	-	CMB7	CMB6	CMB5	CMB4	CMB3	CMB2	CMB1	CMB0		
RDABCSDR	0	↑	1	-	0	1	1	0	1	0	0	0	(68h)	Read Automatic Brightness Control Self-Diagnostic Result
	1	1	↑	-	-	-	-	-	-	-	-	-		Dummy read
	1	1	↑	-	D7	D6	0	0	0	0	0	0		-
RDID1	0	↑	1	-	1	1	0	1	1	0	1	0	(DAh)	Read ID1
	1	1	↑	-	-	-	-	-	-	-	-	-		Dummy read
	1	1	↑	-	ID17	ID16	ID15	ID14	ID13	ID12	ID11	ID10		Read parameter
RDID2	0	↑	1	-	1	1	0	1	1	0	1	1	(DBh)	Read ID2
	1	1	↑	-	-	-	-	-	-	-	-	-		Dummy read
	1	1	↑	-	ID27	ID26	ID25	ID24	ID23	ID22	ID21	ID20		Read parameter
RDID3	0	↑	1	-	1	1	0	1	1	1	0	0	(DCh)	Read ID3

Instruction	D/CX	WRX	RDX	D17-8	D7	D6	D5	D4	D3	D2	D1	D0	Hex	Function
	1	1	↑	-	-	-	-	-	-	-	-	-		Dummy read
	1	1	↑		ID37	ID36	ID35	ID34	ID33	ID32	ID31	ID30		Read parameter

7.2 初始化方法

用户所编的显示程序, 开始必须进行初始化, 否则模块无法正常显示, 过程请参考程序

点亮液晶模块的步骤

硬件准备:
开发板 (或专门设计的主板)、单片机、电源、连接线、仿真器或程序下载器 (又名烧录器)

正确地接线
根据说明书正确地与开发板连接, 连接的线包括: 液晶模块电源线、背光电源线、IO端口 (接口)
IO端口包括: 并口时: CS、RESET、RW、E、RS、D0--D7, 串口时: CS、SCLK、SDA、RESET、RS

编写软件
背光给合适的直流电可以点亮, 但液晶屏里面没有程序, 只给电不能让液晶屏显示 (我们通常说“点亮”), 程序须另外编写, 并烧录 (下载) 到单片机里液晶模块才能工作。

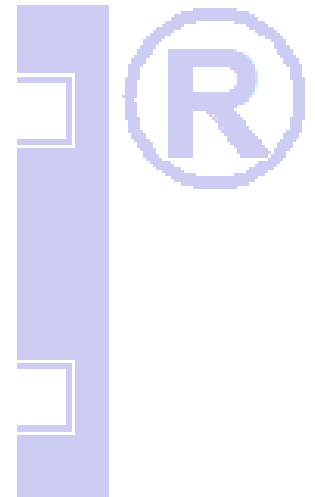
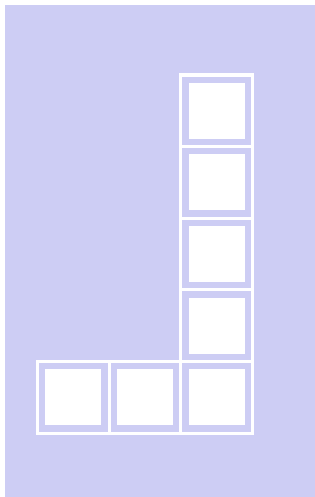

7.3 原理图

20PIN

GND	1	VSS
VDD	2	VDD
D7	3	D7
D6	4	D6
D5	5	D5
D4	6	D4
D3	7	D3
D2	8	D2
D1	9	D1
D0	10	D0
SDA	11	
RD	12	RD
WR	13	WR
DC	14	RS
CS	15	CS
RST	16	RST
IM1	17	VSS
IM2	18	VSS
LEDA	19	3.0V
LEDK	20	VSS

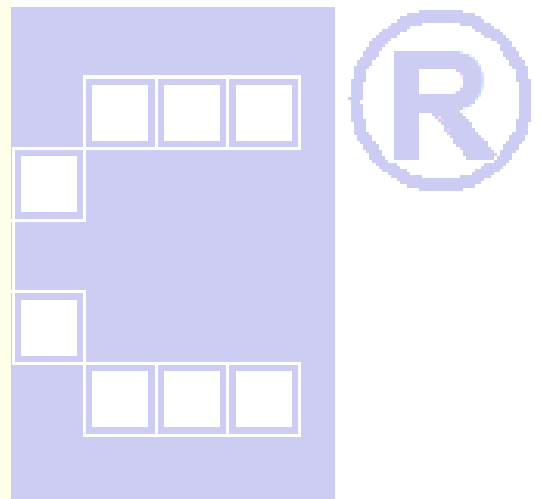

20PIN

7.4 程序

TFT 模块与 MPU (以 8051 系列单片机为例) 接口图如下:



图 4. 并行接口

```
#include <reg51.h>
#include <chinese_code.h>
```

//液晶屏 IC 所需要的信号线的接口定义

```
sbit DC0=P3^2; //RS(A0)
sbit WR0=P3^1; //R/W
sbit RD0=P3^0; //E
sbit CS0=P3^5; //CS
sbit reset=P3^4; //RES
sbit key=P2^0; //P2.0 口与 GND 之间接一个按键
```

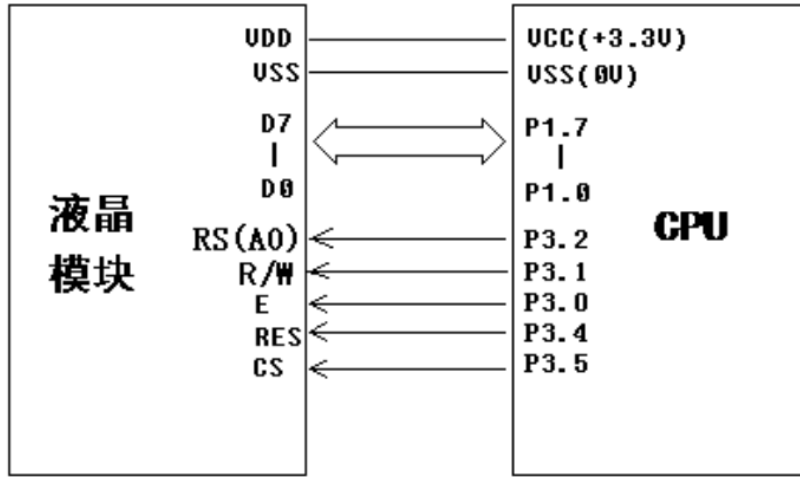
```
void transfer_command(int com1)
{
    CS0 = 0;
    DC0 = 0;
    RD0 = 1;
    P1=com1;
    WR0 = 0;
    delay_us(1);
    WR0 = 1;
    CS0 = 1;
}
```

```
void transfer_data(int data1)
{
    CS0 = 0;
    DC0 = 1;
    RD0 = 1;
    P1=data1;
    WR0 = 0;
    WR0 = 1;
    CS0 = 1;
}
```



```
//连写 2 个字节（即 16 位）数据到 LCD 模块
```

```
void transfer_data_16(uint data_16bit)
{
    transfer_data(data_16bit>>8);
    transfer_data(data_16bit);
}
```

```
void delay(long i)
{
    int j,k;
    for(j=0;j<i;j++)
        for(k=0;k<110;k++);
}
```

```
void delay_us(long i)
```

```
{
    int j,k;
    for(j=0;j<i;j++)
        for(k=0;k<1;k++);
}
```

```
void Switch()
{
    repeat:
        if (key==1) goto repeat;
        else delay(1000);
        if (key) goto repeat;
        else ;
}
```

```
void lcd_initial()
```

```
{
    reset=0;
    delay(200);
    reset=1;
    delay(200);
    //***** Start Initial Sequence *****//

    //-----display and color format setting-----//
    transfer_command(0x36);    //行扫描顺序及 RGB，列扫描顺序，横放/竖放
    transfer_data(0x00);
    transfer_data(0x48);

    transfer_command(0xB6);    //显示功能设置：列/行 显示顺序
    transfer_data(0x0A);
}
```

```

transfer_data(0x82);          //改变 SOURCE 线的方向: 0xa2: 左到右, 0x82: 右到左

transfer_command(0x3a);      //256K 16bit/pixel
transfer_data(0x05);

//-----ST7789V Frame rate setting-----//
transfer_command(0xb2);
transfer_data(0x0c);
transfer_data(0x0c);
transfer_data(0x00);
transfer_data(0x33);
transfer_data(0x33);
transfer_command(0xb7);
transfer_data(0x35);

//-----ST7789V Power setting-----//
transfer_command(0xbb);
transfer_data(0x28);
transfer_command(0xc0);
transfer_data(0x2c);
transfer_command(0xc2);
transfer_data(0x01);
transfer_command(0xc3);
transfer_data(0x10);
transfer_command(0xc4);
transfer_data(0x20);
transfer_command(0xc6);
transfer_data(0x0f);
transfer_command(0xd0);
transfer_data(0xa4);
transfer_data(0xa1);

//-----ST7789V gamma setting-----//
transfer_command(0xe0);
transfer_data(0xd0);
transfer_data(0x00);
transfer_data(0x02);
transfer_data(0x07);
transfer_data(0x0a);
transfer_data(0x28);
transfer_data(0x32);
transfer_data(0x44);
transfer_data(0x42);
transfer_data(0x06);
transfer_data(0x0e);
transfer_data(0x12);
transfer_data(0x14);
transfer_data(0x17);

```

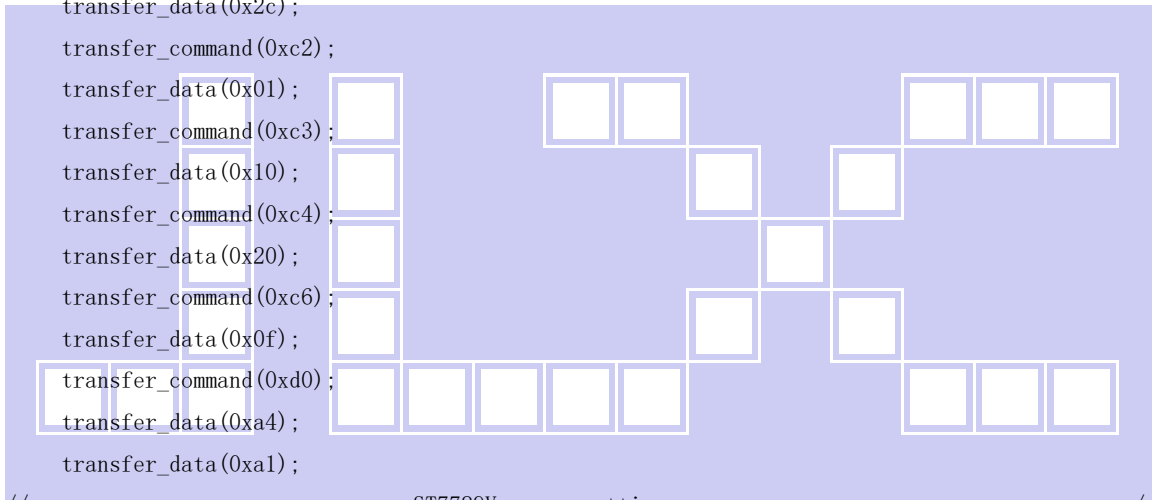

```

transfer_command(0xe1);
transfer_data(0xd0);
transfer_data(0x00);
transfer_data(0x02);
transfer_data(0x07);
transfer_data(0x0a);
transfer_data(0x28);
transfer_data(0x31);
transfer_data(0x54);
transfer_data(0x47);
transfer_data(0x0e);
transfer_data(0x1c);
transfer_data(0x17);
transfer_data(0x1b);
transfer_data(0x1e);

transfer_command(0x11);    //退出睡眠
delay(200);
transfer_command(0x29);    //打开显示
}
//定义窗口坐标：开始坐标 (XS,YS)以及窗口大小 (x_total,y_total)
void lcd_address(int XS,int YS,int x_total,int y_total)
{
    int XE,YE;
    XE=XS+x_total-1;
    YE=YS+y_total-1;
    transfer_command(0x2a);    // 设置 X 开始及结束的地址
    transfer_data_16(XS);    // X 开始地址(16 位)
    transfer_data_16(XE);    // X 结束地址(16 位)

    transfer_command(0x2b);    // 设置 Y 开始及结束的地址
    transfer_data_16(YS);    // Y 开始地址(16 位)
    transfer_data_16(YE);    // Y 结束地址(16 位)

    transfer_command(0x2c);    // 写数据开始
}

void mono_transfer_data_16(int mono_data,int font_color,int back_color)
{
    int i;
    for(i=0;i<8;i++)
    {
        if(mono_data&0x80)
        {
            transfer_data_16(font_color);    //当数据是 1 时，显示字体颜色
        }
    }
}

```



```

    }
    else
    {
        transfer_data_16(back_color); //当数据是 0 时，显示底色
    }
    mono_data<<=1;
}
}

```

//全屏显示一种颜色

```
void display_color(int color_data)
```

```

{
    int i, j;
    lcd_address(0, 0, 240, 320);
    for(i=0; i<240; i++)
    {

```

```

        for(j=0; j<320; j++)
        {
            transfer_data_16(color_data);
        }
    }
}

```

```
void display_black(void)
```

```

{
    int i, j, k;
    transfer_command(0x2c); // 写数据开始
    for(i=0; i<240; i++)
    {

```

```

        transfer_data_16(0xffff);
    }
    for(i=0; i<318; i++)
    {
        for(k=0; k<1; k++)
        {
            transfer_data_16(0xffff);
        }
        for(j=0; j<238; j++)
        {
            transfer_data_16(0x0000);
        }
        for(k=0; k<1; k++)
        {
            transfer_data_16(0xffff);
        }
    }
}

```



```

    }
    for(i=0;i<320;i++)
    {
        transfer_data_16(0xffff);
    }
}

//显示 8x16 点阵的字符串
void disp_string_8x16(int x,int y,char *text,int font_color,int back_color)
{

```

```

    int i=0,j,k;
    while(text[i]>0x00)
    {
        if((text[i]>=0x20)&&(text[i]<=0x7e))
        {
            j=text[i]-0x20;
            lcd_address(x,y,8,16);
            for(k=0;k<16;k++)
            {
                mono_transfer_data_16(ascii_table_8x16[j*16+k],font_color,back_color);
                //?a??ascii_table_8x16[]"?a??ÿ×é?ú"ASCII_TABLE_5X8_8X16_horizontal.h"à?
            }
            x+=8;
            i++;
        }
        else
        {
            i++;
        }
    }
}

```

```

void display_string_16x16(int x,int y,uchar *text,int font_color,int back_color)
{
    uchar i,j,k;
    uint address;
    j = 0;
    while(text[j] != '\0') //'\0' 字符串结束标志
    {
        i = 0;
        address = 1;
        while(Chinese_horizontal_text_16x16[i] > 0x7e) // >0x7f 即说明不是 ASCII 码字符
        {
            if(Chinese_horizontal_text_16x16[i] == text[j])
            {
                if(Chinese_horizontal_text_16x16[i + 1] == text[j + 1])
                {
                    address = i * 16;

```



```

        break;
    }
}
i += 2;
}
if(y > 320)
{
    y=0;
    x+=16;
}

if(address != 1)// 显示汉字
{
    lcd_address(x, y, 16, 16);
    for(i=0;i<2;i++)
    {
        for(k = 0; k <16; k++)
        {
            mono_transfer_data_16(Chinese_horizontal_code_16x16[address], font_color, back_color);
            address++;
        }
        j+=2;
    }
    else //显示空白字符
    {
        lcd_address(x, y, 16, 16);
        for(i = 0; i <2; i++)
        {
            for(k = 0; k < 16; k++)
            {
                mono_transfer_data_16(0x00, font_color, back_color);
            }
        }
        j+=2;
    }
    x=x+16;
}
}

```

//显示 32x32 点阵的单色的图像

```

void disp_32x32(int x, int y, char *dp, int font_color, int back_color)
{
    int i, j;
    lcd_address(x, y, 32, 32);

```

```

for(i=0;i<32;i++)
{
    for(j=0;j<4;j++)
    {
        mono_transfer_data_16(*dp, font_color, back_color);
        dp++;
    }
}

```

//显示一幅彩图

```

void display_image(int x,int y,uchar *dp)
{

```

```

    uchar i, j, k=0;

```

```

    lcd_address(x, y, 120, 160);

```

```

    for(i=0;i<120;i++)
    {

```

```

        for(j=0;j<160;j++)
        {

```

```

            transfer_data(*dp);

```

```

            dp++;

```

```

            transfer_data(*dp);

```

```

            dp++;
        }
    }
}

```

```

void main(void)
{

```

```

    lcd_initial();

```

```

    while(1)
    {

```

```

        display_color(blue);

```

```

        disp_32x32(40+32*0, 8, jing_32x32, white, blue);

```

```

        disp_32x32(40+32*1, 8, lian_32x32, white, blue);

```

```

        disp_32x32(40+32*2, 8, xun_32x32, white, blue);

```

```

        disp_32x32(40+32*3, 8, dian_32x32, white, blue);

```

```

        disp_32x32(40+32*4, 8, zi_32x32, white, blue);

```

```

        display_string_16x16(24, 56, "深圳市晶联讯电子有限公司", white, blue);

```

```

        display_string_16x16(48, 88, "型号", white, blue);

```

```

        disp_string_8x16(80, 88, ": JLX240-00301-BN", white, blue);

```

```

        display_string_16x16(48, 120, "视窗", white, blue);

```

```

        disp_string_8x16(80, 120, ": 36.7x48.9mm", white, blue);

```

```

        display_string_16x16(48, 152, "驱动", white, blue);

```

```

        disp_string_8x16(80, 152, "IC: ST7789V", white, blue);
    }
}

```

```
display_string_16x16(0, 184, "经营宗旨：制造高品质产品及服务", white, blue);
display_string_16x16(0, 216, "质量方针：客户至上，质量保证", white, blue);
display_string_16x16(79, 236, "持续改进，服务到位", white, blue);
display_string_16x16(0, 270, "经营目标：做最好的液晶模块厂家", white, blue);
display_string_16x16(79, 292, "做客户信得过的企业", white, blue);
Switch();
```

```
display_image(0, 0, pic1);
display_image(120, 0, pic1);
display_image(0, 160, pic1);
display_image(120, 160, pic1);
Switch();
```

```
display_color(0xf800);
Switch();
display_color(0x07e0);
Switch();
```

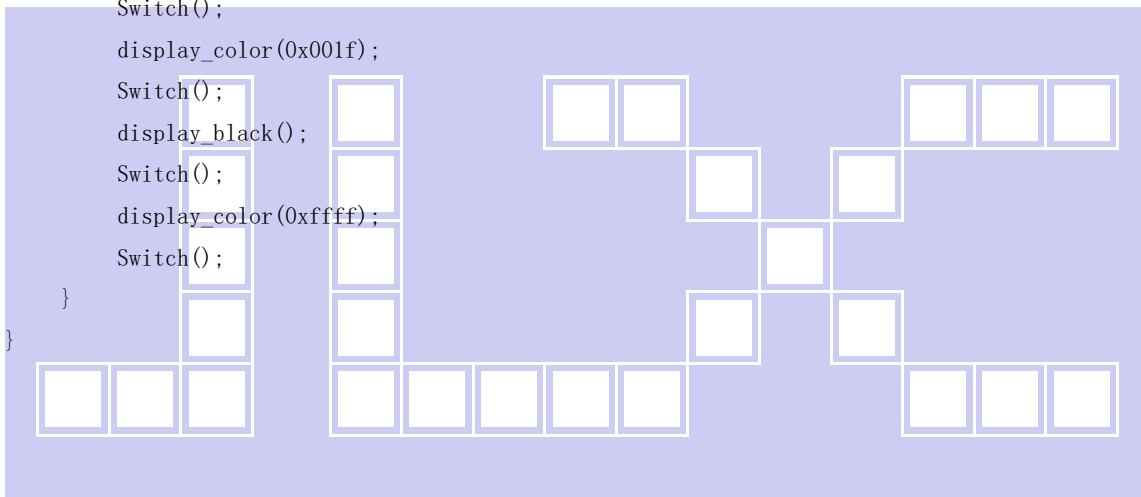

```
display_color(0x001f);
Switch();
display_black();
Switch();
display_color(0xffff);
Switch();
}
}
```

7.5 串口原理图：

20PIN

GND	1	VSS
VDD	2	3.3V
D7	3	
D6	4	
D5	5	
D4	6	
D3	7	
D2	8	
D1	9	
D0	10	
SDA	11	SDA
RD	12	
WR	13	RS
DC	14	SCK
CS	15	CS
RST	16	RST
IM1	17	3.3V
IM2	18	3.3V
LEDA	19	3.0V
LEDK	20	VSS

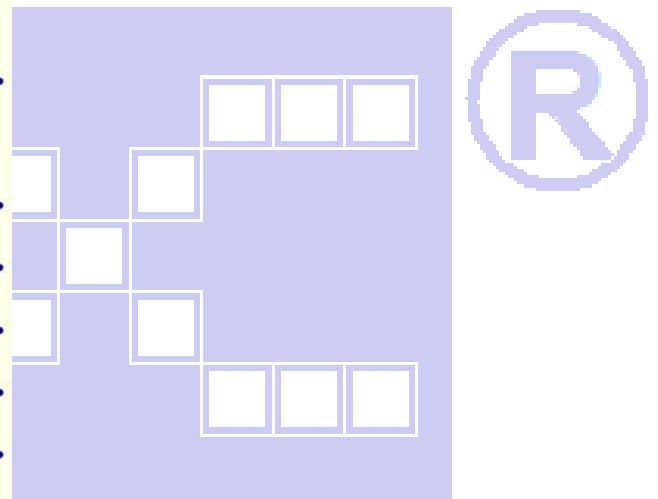

7.6 程序举例：

串行接口

液晶模块与 MPU(以 8051 系列单片机为例)接口图如下：



图 8. 串行接口

串程序与并行, 只是接口定义、写数据和命令不一样, 其它都一样

```

#include <STC15F2K60S2.H>
#include <chinese_code.h>

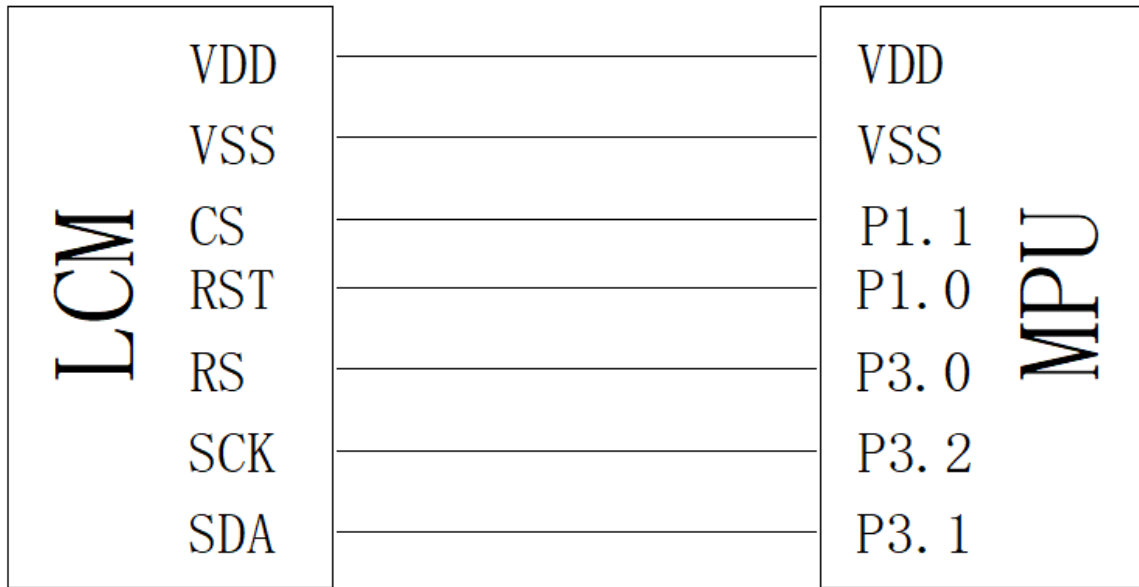
//液晶屏 IC 所需要的信号线的接口定义
sbit cs1=P1^1;    //CS
sbit reset=P1^0; //RST
sbit rs=P3^0;    //RS
sbit sclk=P3^2;  //SCK
sbit sid=P3^1;   //SDA
sbit key=P2^0;   //P2.0 口与 GND 之间接一个按键
    
```

```

/*写指令到 LCD 模块*/
void transfer_command(int data1)
{
    char i;
    cs1=0;
    rs=0;
    for(i=0;i<8;i++)
    {
        sclk=0;
        if(data1&0x80) sid=1;
        else sid=0;
        sclk=1;
        data1=data1<<=1;
    }
    cs1=1;
}
    
```



/*写数据到 LCD 模块*/

```
void transfer_data(int data1)
{
    char i;
    cs1=0;
    rs=1;
    for(i=0;i<8;i++)
    {
        sclk=0;
        if(data1&0x80) sid=1;
        else sid=0;
        sclk=1;
        data1=data1<<=1;
    }
    cs1=1;
}
```

