

JLX144-01601-BN 使用说明书

(插接式 FPC)

目 录

序号	内 容 标 题	页 码
1	概述	2
2	特点	2
3	外形及接口引脚功能	3~4
4	基本原理	4
5	技术参数	4~5
6	时序特性	5~6
7	指令功能及硬件接口与编程案例	7~末页

1. 概述

晶联讯电子专注于液晶屏及液晶模块的研发、制造。所生产 JLX144-01601-BN 型液晶模块由于使用方便、显示清晰，广泛应用于各种人机交流面板。

JLX144-01601-BN 可以显示 128 列*128 行点阵彩色图片。

2. JLX144-01601-BN 彩色图像型点阵液晶模块的特性

2.1 TFT 串行接口。

2.2 结构轻、薄、带背光。

2.3 IC 采用 ST7735S, 功能强大，性能稳定。

2.4 指令功能强：例如可以用指令控制显示内容顺时针旋转 90°、逆时针旋转 90° 或倒立竖放。

2.5 接口简单方便：**采用 4 线 SPI 串口。**

2.6 工作温度宽：-20℃ - 70℃；

2.7 储存温度宽：-30℃ - 80℃；

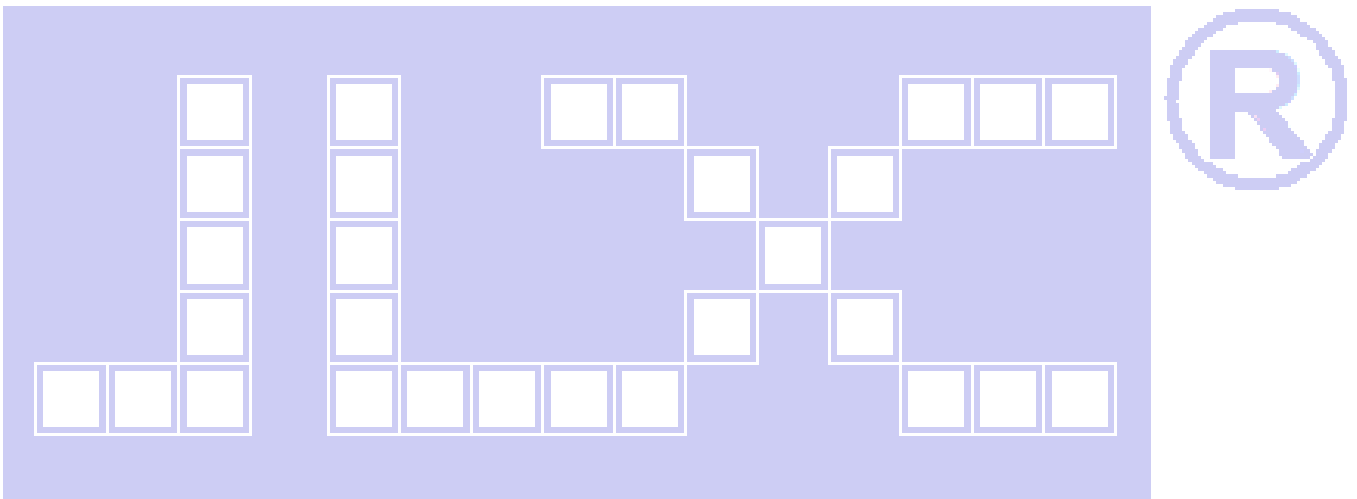

3. 外形尺寸及接口引脚功能



图 1. 外形尺寸

模块的接口引脚功能

引线号	符号	名称	功能
1	GND	接地	0V
2	VDD	电路电源	3.3V
3	SCK	串行时钟	串行时钟
4	RST	复位	低电平复位, 复位完成后, 回到高电平, 液晶模块开始工作
5	CS	片选	低电平片选
6	SDA	串行数据	串行数据
7	A0 (RS)	寄存器选择信号	H: 数据寄存器 0: 指令寄存器 (IC 资料上所写为 "A0")
8	LEDA	背光电源正极	接 3.0V
9	LEDK	背光电源负极	接地 0V
10	NC	空脚	空脚

表 1: 模块的接口引脚功能

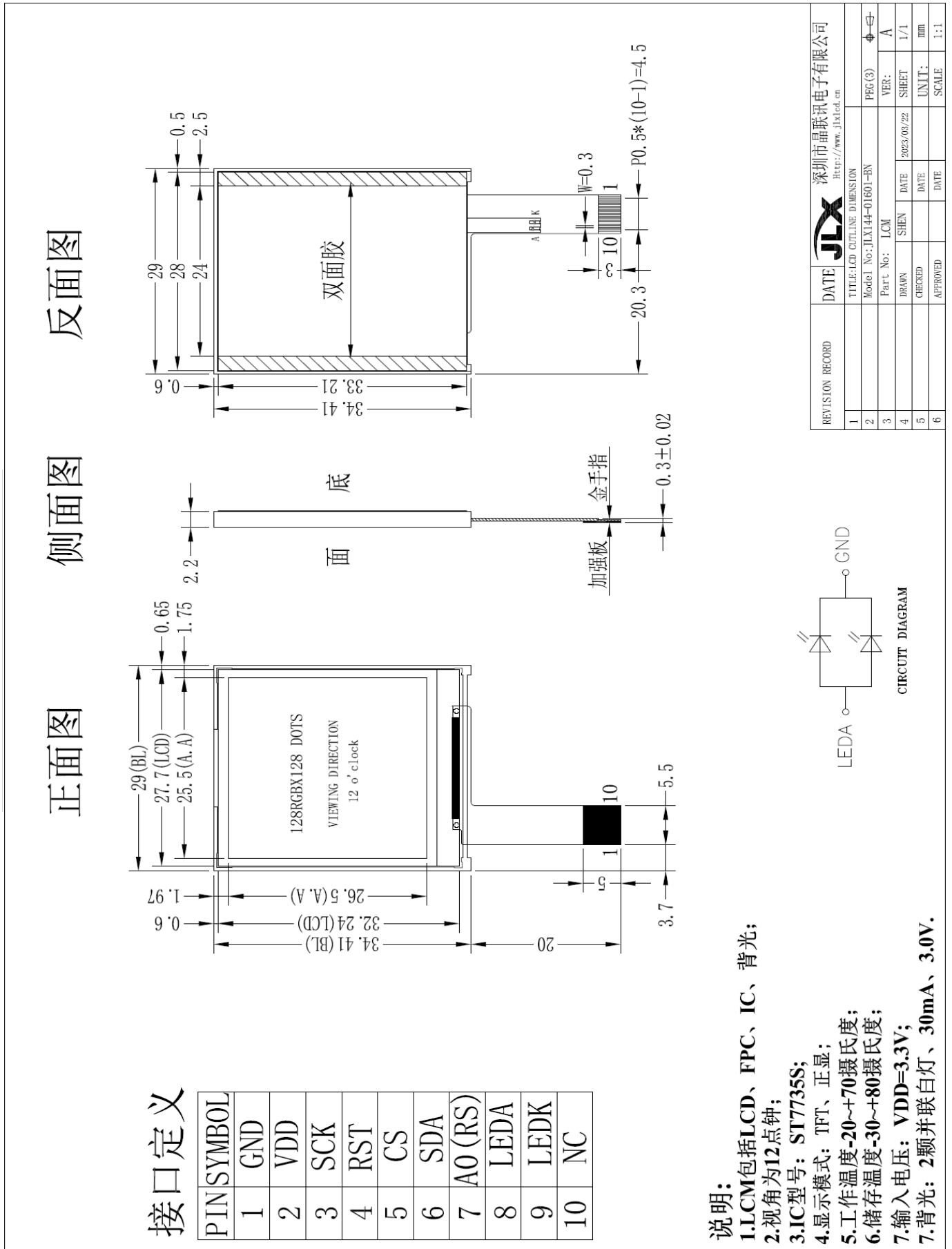
4. 基本原理

4.1 液晶屏 (LCD)

在 LCD 上排列着 128×128 点阵, 128 个列信号与驱动 IC 相连, 128 个行信号也与驱动 IC 相连, IC 邦定在 LCD 玻璃上。

4.3 背光参数

该型号液晶模块带 LED 背光源。它的性能参数如下:

工作温度: -20~+70° C;

存储温度: -30~+80° C;

背光板是白色。

正常工作电流为: 16~40mA (LED 灯数共 2 颗, 每颗灯是 8~20 mA)。

工作电压: 3.0V (3.3V 供电加 20 欧限流电阻, 5.0V 供电加 120 欧限流电阻)。

5. 技术参数

5.1 最大极限参数 (超过极限参数则会损坏液晶模块)

名称	符号	标准值			单位
		最小	典型	最大	
电路电源	VDD	-0.3	3.3	3.6	V
工作温度		-20		+70	°C
储存温度		-30		+80	°C

表 2: 最大极限参数

5.2 直流 (DC) 参数

名称	符号	测试条件	标准值			单位
			最小	典型值	最大	
工作电压	VDD		2.8	3.3	3.6	V
背光工作电压	VLED		2.9	3.0	3.1	V
背光工作电流	ILED	VLED=3.0V, 共 2 颗 LED 灯并联	16	30	40	mA

表 3: 直流 (DC) 参数

6. 读写时序特性

详见 IC 资料 “ST7735S”，请找相关客服人员索要。

4 线 SPI 时序图

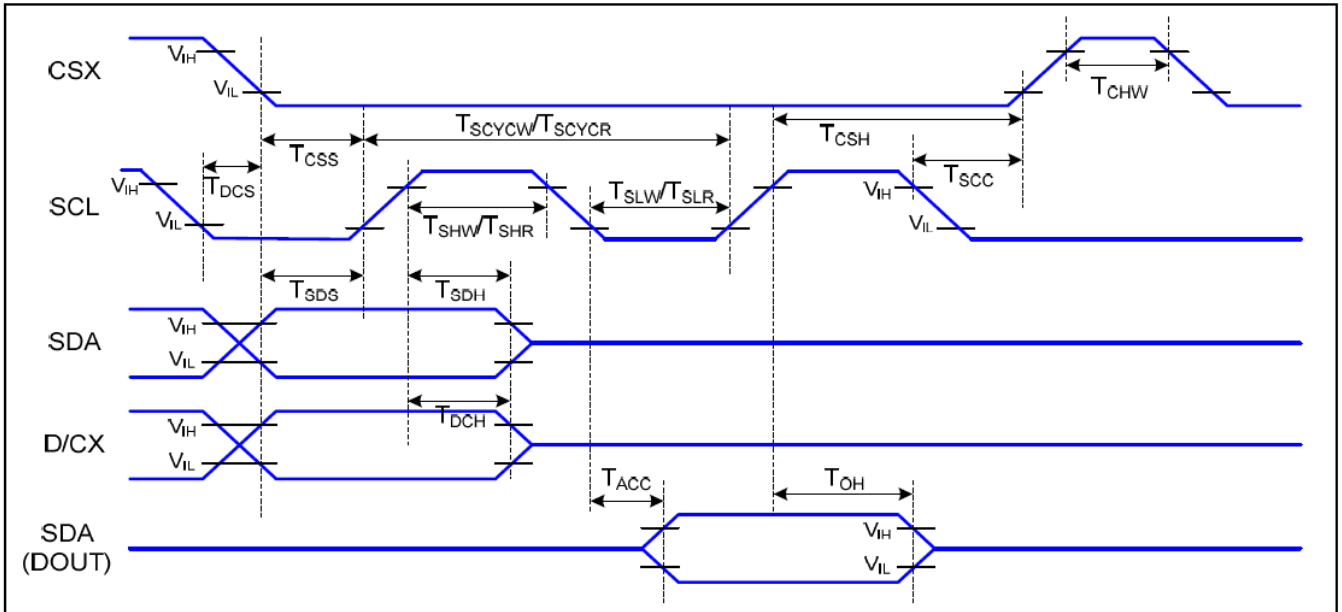

Signal	Symbol	Parameter	MIN	MAX	Unit	Description
CSX	TCSS	Chip Select Setup Time (Write)	TBD		ns	
	TCSH	Chip Select Hold Time (Write)	TBD		ns	
	TCSS	Chip Select Setup Time (Read)	TBD		ns	
	TSCC	Chip Select Hold Time (Read)	TBD		ns	
	TCHW	Chip Select "H" Pulse Width	TBD		ns	
SCL	TSCYCW	Serial Clock Cycle (Write)	TBD		ns	-Write Command & Data Ram
	TSHW	SCL "H" Pulse Width (Write)	TBD		ns	
	TSLW	SCL "L" Pulse Width (Write)	TBD		ns	
	TSCYCR	Serial Clock Cycle (Read)	TBD		ns	-Read Command & Data Ram
	TSHR	SCL "H" Pulse Width (Read)	TBD		ns	
	TSLR	SCL "L" Pulse Width (Read)	TBD		ns	
D/CX	TDCS	D/CX Setup Time	TBD		ns	
	TDCH	D/CX Hold Time	TBD		ns	
SDA (DIN) (DOUT)	TSDS	Data Setup Time	TBD		ns	For Maximum CL=30pF For Minimum CL=8pF
	TSDH	Data Hold Time	TBD		ns	
	TACC	Access Time	TBD	TBD	ns	
	TOH	Output Disable Time	TBD	TBD	ns	

6.1 电源启动后复位的时序要求 (RESET CONDITION AFTER POWER UP):

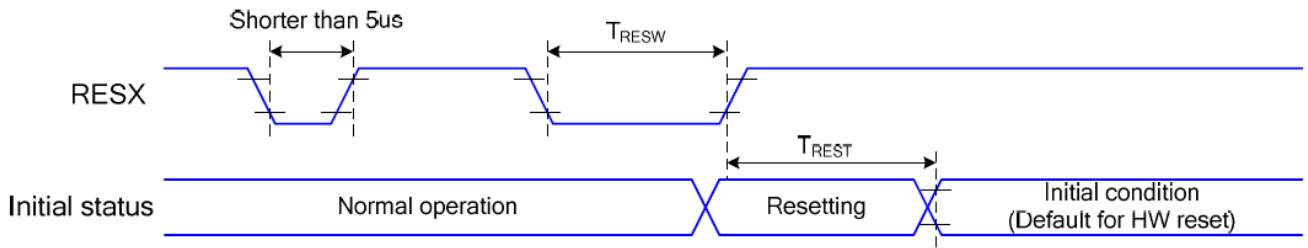

图为电源启动后复位的时序

电源启动后复位的时序要求

项目	符号	测试条件	极限值			单位
			MIN	TYPE	MAX	
复位保持低电平的时间	t_{Res-L}		5	—	—	ms
复位时间	T_{rRES}	引脚: RES	10	—	—	us
复位保持高电平的时间	T_{RES-H}		120	—	—	ms

7. 指令功能:

7.1 指令表 1

指令表

Instruction	Refer	D/CX	WRX	RDX	D17-8	D7	D6	D5	D4	D3	D2	D1	D0	Hex	Function
NOP	0	0	↑	1	-	0	0	0	0	0	0	0	0	(00h)	No Operation
SWRESET	0	0	↑	1	-	0	0	0	0	0	0	0	1	(01h)	Software Reset
RDDID	0	0	↑	1	-	0	0	0	0	0	1	0	0	(04h)	Read Display ID
		1	1	↑	-	-	-	-	-	-	-	-	-	-	Dummy Read
		1	1	↑	-	ID17	ID16	ID15	ID14	ID13	ID12	ID11	ID10	-	ID1 Read
		1	1	↑	-	1	ID26	ID25	ID24	ID23	ID22	ID21	ID20	-	ID2 Read
		1	1	↑	-	ID37	ID36	ID35	ID34	ID33	ID32	ID31	ID30	-	ID3 Read
RDDST	0	0	↑	1	-	0	0	0	0	1	0	0	1	(09h)	Read Display Status
		1	1	↑	-	-	-	-	-	-	-	-	-	-	Dummy Read
		1	1	↑	-	BSTON	MY	MX	MV	ML	RGB	MH	ST24	-	-
		1	1	↑	-	ST23	IFPF2	IFPF1	IFPF0	IDMON	PTLON	SLOUT	NORON	-	-
		1	1	↑	-	VSSON	ST14	INVON	ST12	ST11	DISON	TEON	GCS2	-	-
1	1	↑	-	GCS1	GCS0	TEM	ST4	ST3	ST2	ST1	ST0	-	-		
RDDPM	0	0	↑	1	-	0	0	0	0	1	0	1	0	(0Ah)	Read Display Power Mode
		1	1	↑	-	-	-	-	-	-	-	-	-	-	Dummy Read
		1	1	↑	-	BSTON	IDMON	PTLON	SLPOUT	NORON	DISON	-	-	-	-
RDD MADCTL	0	0	↑	1	-	0	0	0	0	1	0	1	1	(0Bh)	Read Display MADCTL
		1	1	↑	-	-	-	-	-	-	-	-	-	-	Dummy Read
		1	1	↑	-	MY	MX	MV	ML	RGB	MH	-	-	-	-
RDD COLMOD	0	0	↑	1	-	0	0	0	0	1	1	0	0	(0Ch)	Read Display Pixel Format
		1	1	↑	-	-	-	-	-	-	-	-	-	-	Dummy Read
		1	1	↑	-	0	0	0	0	-	IFPF2	IFPF1	IFPF0	-	-
RDDIM	0	0	↑	1	-	0	0	0	0	1	1	0	1	(0Dh)	Read Display Image Mode
		1	1	↑	-	-	-	-	-	-	-	-	-	-	Dummy Read
		1	1	↑	-	VSSON	D6	INVON	-	-	GCS2	GCS1	GCS0	-	-
RDDSM	0	0	↑	1	-	0	0	0	0	1	1	1	0	(0Eh)	Read Display Signal Mode
		1	1	↑	-	-	-	-	-	-	-	-	-	-	Dummy Read
		1	1	↑	-	TEON	TEM	-	-	-	-	-	-	-	-
RDDSDR	0	0	↑	1	-	0	0	0	0	1	1	1	1	(0Fh)	Read Display Self-diagnostic
		1	1	↑	-	-	-	-	-	-	-	-	-	-	Dummy Read
		1	1	↑	-	RELD	FUND	ATTD	BRD	-	-	-	-	-	-

7.2 指令表 2

Instructi	Refer	D/CX	WRX	RDX	D17-8	D7	D6	D5	D4	D3	D2	D1	D0	Hex	Function
SLPIN	0	0	↑	1	-	0	0	0	1	0	0	0	0	(10h)	Sleep In & Booster Off
SLPOUT	0	0	↑	1	-	0	0	0	1	0	0	0	1	(11h)	Sleep Out & Booster On
PTLON	0	0	↑	1	-	0	0	0	1	0	0	1	0	(12h)	Partial Mode On
NORON	0	0	↑	1	-	0	0	0	1	0	0	1	1	(13h)	Partial Off (Normal)
INVOFF	0	0	↑	1	-	0	0	1	0	0	0	0	0	(20h)	Display Inversion Off (Normal)
INVON	0	0	↑	1	-	0	0	1	0	0	0	0	1	(21h)	Display Inversion On
GAMSET	0	0	↑	1	-	0	0	1	0	0	1	1	0	(26h)	Gamma Curve Select
		1	↑	1	-	-	-	-	-	GC3	GC2	GC1	GC0		-
DISPOFF	0	0	↑	1	-	0	0	1	0	1	0	0	0	(28h)	Display Off
DISPON	0	0	↑	1	-	0	0	1	0	1	0	0	1	(29h)	Display On
CASET	0	0	↑	1	-	0	0	1	0	1	0	1	0	(2Ah)	Column Address Set
		1	↑	1	-	XS15	XS14	XS13	XS12	XS11	XS10	XS9	XS8		X Address Start: $0 \leq XS \leq X$
		1	↑	1	-	XS7	XS6	XS5	XS4	XS3	XS2	XS1	XS0		
		1	↑	1	-	XE15	XE14	XE13	XE12	XE11	XE10	XE9	XE8		X Address End: $S \leq XE \leq X$
RASET	0	1	↑	1	-	XE7	XE6	XE5	XE4	XE3	XE2	XE1	XE0		
		0	↑	1	-	0	0	1	0	1	0	1	1	(2Bh)	Row Address Set
		1	↑	1	-	YS15	YS14	YS13	YS12	YS11	YS10	YS9	YS8		Y Address Start: $0 \leq YS \leq Y$
		1	↑	1	-	YS7	YS6	YS5	YS4	YS3	YS2	YS1	YS0		
RAMWR	0	1	↑	1	-	YE15	YE14	YE13	YE12	YE11	YE10	YE9	YE8		Y Address End: $S \leq YE \leq Y$
		1	↑	1	-	YE7	YE6	YE5	YE4	YE3	YE2	YE1	YE0		
		0	↑	1	-	0	0	1	0	1	1	0	0	(2Ch)	Memory Write
		1	↑	1	-	D7	D6	D5	D4	D3	D2	D1	D0		Write Data
RGBSET	0	0	↑	1	-	0	0	1	0	1	1	0	1	(2Dh)	LUT for 4k,65k,262k Color display
		1	↑	1	-	-	-	R005	R004	R003	R002	R001	R000		Red Tone 0
		1	↑	1	-	-	-	:	:	:	:	:	:		:
		1	↑	1	-	-	-	Ra5	Ra4	Ra3	Ra2	Ra1	Ra0		Red Tone "a"
		1	↑	1	-	-	-	G005	G004	G003	G002	G001	G000		Green Tone 0
		1	↑	1	-	-	-	:	:	:	:	:	:		:
		1	↑	1	-	-	-	Gb5	Gb4	Gb3	Gb2	Gb1	Gb0		Green Tone "b"
		1	↑	1	-	-	-	B005	B004	B003	B002	B001	B000		Blue Tone 0
		1	↑	1	-	-	-	:	:	:	:	:	:		:
		1	↑	1	-	-	-	Bc5	Bc4	Bc3	Bc2	Bc1	Bc0		Blue Tone "c"
RAMRD	0	0	↑	1	-	0	0	1	0	1	1	1	0	(2Eh)	Memory Read
		1	1	↑	-	-	-	-	-	-	-	-	-		Dummy Read
		1	1	↑	-	D7	D6	D5	D4	D3	D2	D1	D0		Read Data

7.3 指令表 3

Instruction	Refer	D/CX	WRX	RDX	D17-8	D7	D6	D5	D4	D3	D2	D1	D0	Hex	Function	
PTLAR	0	0	↑	1	-	0	0	1	1	0	0	0	0	(30h)	Partial Start/End Address Set	
		1	↑	1	-	PSL15	PSL14	PSL13	PSL12	PSL11	PSL10	PSL9	PSL8		Partial Start Address (0,1,2, ...P)	
		1	↑	1	-	PEL15	PEL14	PEL13	PEL12	PEL11	PEL10	PEL9	PEL8		Partial End Address (0,1,2, ... P)	
		1	↑	1	-	PEL7	PEL6	PEL5	PEL4	PEL3	PEL2	PEL1	PEL0			
SCRLAR	10.1.26	0	↑	1	-	0	0	1	1	0	0	1	1	(33h)	Scroll area set	
		1	↑	1	-	-	-	-	-	-	-	-	-		Top fixed area (0,1, 2, ... 161)	
		1	↑	1	-	TFA7	TFA6	TFA5	TFA4	TFA3	TFA2	TFA1	TFA0			
		1	↑	1	-	-	-	-	-	-	-	-	-	-		Vertical scroll area (0,1, 2, ... 161)
		1	↑	1	-	VSA7	VSA6	VSA5	VSA4	VSA3	VSA2	VSA1	VSA0			
		1	↑	1	-	-	-	-	-	-	-	-	-	-		Bottom fixed area (0,1, 2, ... 161)
TEOFF	10.1.27	0	↑	1	-	0	0	1	1	0	1	0	0	(34h)	Tearing effect line off	
TEON	08	0	↑	1	-	0	0	1	1	0	1	0	1	(35h)	Tearing Effect Mode Set & on	
		1	↑	1	-	-	-	-	-	-	-	-	TEM		Mode1: TEM="0" Mode2: TEM="1"	
MADCTL	09	0	↑	1	-	0	0	1	1	0	1	1	0	(36h)	Memory Data Access Control	
		1	↑	1	-	MY	MX	MV	ML	RGB	MH	-	-			
VSCSAD	10.1.30	0	↑	1	-	0	0	1	1	0	1	1	1	(37h)	Scroll Start Address of RAM	
		1	1	1	-	-	-	-	-	-	-	-	-			
		1	1	1	-	SSA7	SSA6	SSA5	SSA4	SSA3	SSA2	SSA1	SSA0		SSA=0,1,2, ..., 161	
IDMOFF	031	0	↑	1	-	0	0	1	1	1	0	0	0	(38h)	Idle Mode Off	
IDMON	02	0	↑	1	-	0	0	1	1	1	0	0	1	(39h)	Idle Mode On	
COLMOD	03	0	↑	1	-	0	0	1	1	1	0	1	0	(3Ah)	Interface Pixel Format	
		1	↑	1	-	-	-	-	-	-	IFPF2	IFPF1	IFPF0		Interface Format	
RDID1	04	0	↑	1	-	1	1	0	1	1	0	1	0	(DAh)	Read ID1	
		1	1	↑	-	-	-	-	-	-	-	-	-		Dummy Read	
		1	1	↑	-	ID17	ID16	ID15	ID14	ID13	ID12	ID11	ID10		Read Parameter	
RDID2	05	0	↑	1	-	1	1	0	1	1	0	1	1	(DBh)	Read ID2	
		1	1	↑	-	-	-	-	-	-	-	-	-		Dummy Read	
		1	1	↑	-	1	ID26	ID25	ID24	ID23	ID22	ID21	ID20		Read Parameter	
RDID3	06	0	↑	1	-	1	1	0	1	1	1	0	0	(DCh)	Read ID3	
		1	1	↑	-	-	-	-	-	-	-	-	-		Dummy Read	
		1	1	↑	-	ID37	ID36	ID35	ID34	ID33	ID32	ID31	ID30		Read Parameter	

7.2 初始化方法

用户所编的显示程序, 开始必须进行初始化, 否则模块无法正常显示, 过程请参考程序

点亮液晶模块的步骤

硬件准备:
开发板 (或专门设计的主板)、单片机、电源、连接线、仿真器或程序下载器 (又名烧录器)

正确地接线
根据说明书正确地与开发板连接, 连接的线包括: 液晶模块电源线、背光电源线、IO端口 (接口)
IO端口包括: 并口时: CS、RESET、RW、E、RS、D0--D7, 串口时: CS、SCLK、SDA、RESET、RS

编写软件
背光给合适的直流电可以点亮, 但液晶屏里面没有程序, 只给电不能让液晶屏显示 (我们通常说“点亮”), 程序须另外编写, 并烧录 (下载) 到单片机里液晶模块才能工作。

7.3 程序举例:

液晶模块与 MPU (以 8051 系列单片机为例) 接口图如下: 串行接口

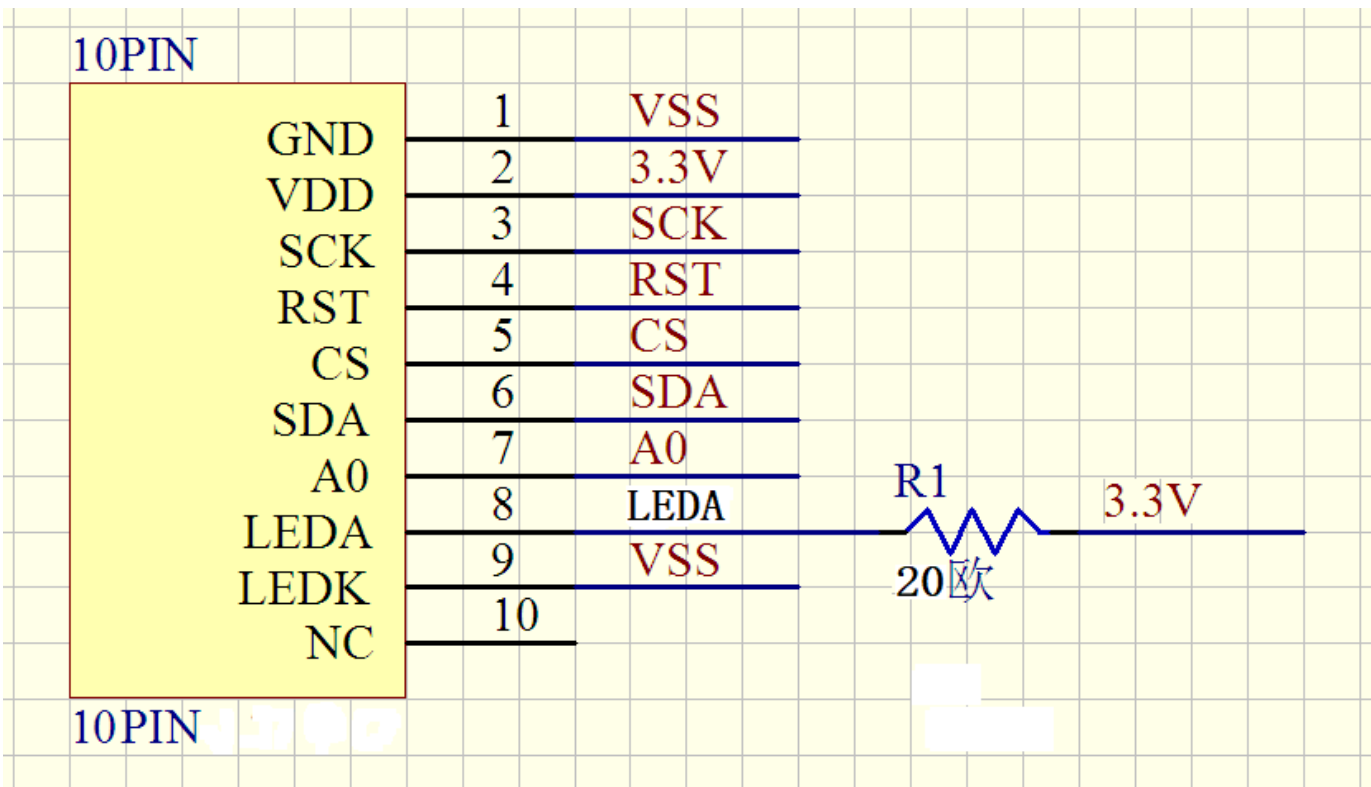
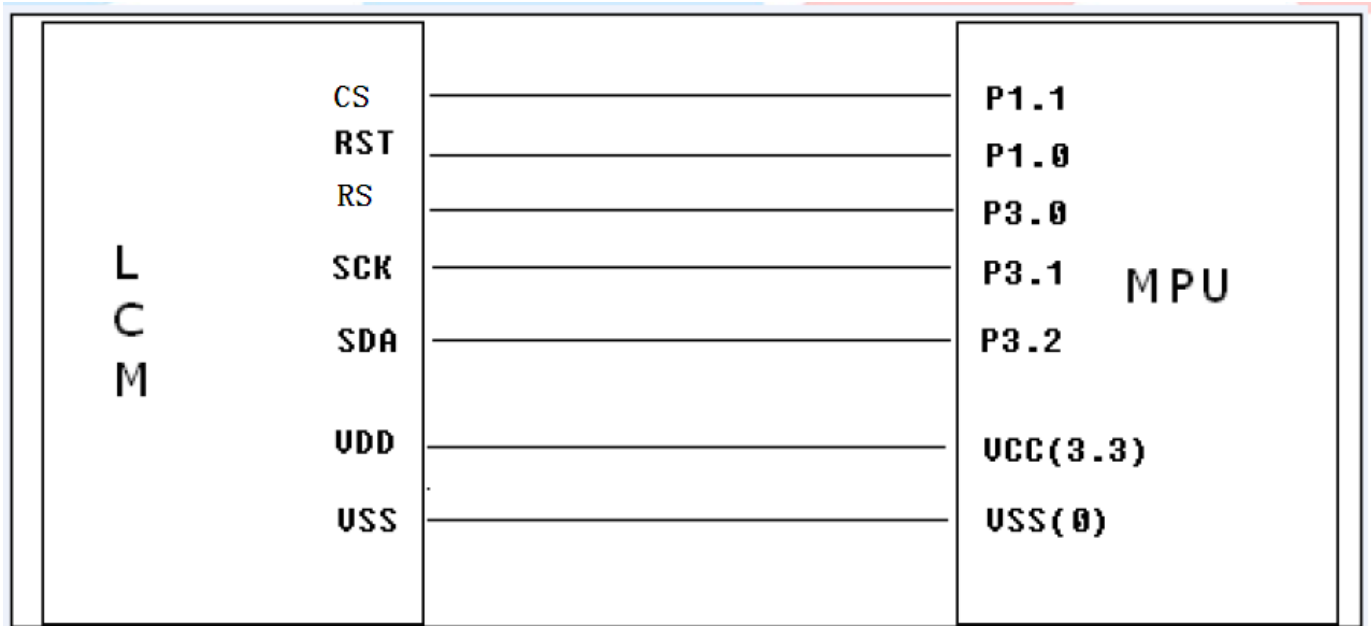

//版权所有：深圳市晶联讯电子有限公司，网址：www.jlxlcd.cn

```
#include <reg52.h>
```

```
#include <stdio.h>
```

//液晶屏 IC 所需要的信号线的接口定义

```
sbit CS=P1^1;
```

```
sbit RST=P1^0;
```

```
sbit RS=P3^0;
```

```
sbit SCK=P3^1;
```

```
sbit SDA=P3^2;
```

```

sbit key=P2^0; //P2.0 口与 GND 之间接一个按键
//=====

#define uchar unsigned char
#define uint unsigned int
#define ulong unsigned long

//定义彩屏旋转方向
#define normal 0xc8
#define CW90 0x68
#define CCW90 0xa8
#define CW180 0x08

#define red 0xf800 //定义红色
#define blue 0x001f //定义蓝色
#define green 0x07e0 //定义绿色
#define deep_green 0x0600 //定义深绿色
#define white 0xffff //定义白色
#define black 0x0000 //定义黑色
#define orange 0xfc08 //定义橙色
#define yellow 0xffe0 //定义黄色
#define pink 0xf3f3 //定义粉红色
#define purple 0xald6 //定义紫色
#define brown 0x8200 //定义棕色
#define gray 0xc618 //定义灰色

uchar code jing[]={ //横向取模
/*-- 文字: 晶 --*/
/*-- 宋体 23; 此字体下对应的点阵为: 宽 x 高=31x31 --*/
/*-- 宽度不是 8 的倍数, 现调整为: 宽度 x 高度=32x31 --*/
0x00, 0x00, 0x00, 0x00, 0x00, 0x00, 0x00, 0x00, 0x00, 0x00, 0x03, 0x00, 0x00, 0xF0, 0x07, 0x80,
0x00, 0xFF, 0xFF, 0x80, 0x00, 0xF0, 0x07, 0x00, 0x00, 0xF0, 0x07, 0x00, 0x00, 0xF0, 0x07, 0x00,
0x00, 0xFF, 0xFF, 0x00, 0x00, 0xF0, 0x07, 0x00, 0x00, 0xF0, 0x07, 0x00, 0x00, 0xF0, 0x07, 0x00,
0x00, 0xFF, 0xFF, 0x00, 0x00, 0xF0, 0x07, 0x00, 0x00, 0xC0, 0x00, 0x00, 0x18, 0x0C, 0x40, 0x30,
0x1F, 0xFE, 0x7F, 0xF8, 0x1C, 0x1E, 0x70, 0x78, 0x1C, 0x1C, 0x70, 0x70, 0x1C, 0x1C, 0x70, 0x70,
0x1C, 0x1C, 0x70, 0x70, 0x1C, 0x1C, 0x70, 0x70, 0x1F, 0xFC, 0x7F, 0xF0, 0x1C, 0x1C, 0x70, 0x70,
0x1C, 0x1C, 0x70, 0x70, 0x1C, 0x1C, 0x70, 0x70, 0x1C, 0x1C, 0x70, 0x70, 0x1F, 0xFC, 0x7F, 0xF0,
0x1C, 0x1C, 0x70, 0x70, 0x18, 0x00, 0x60, 0x00, 0x00, 0x00, 0x00, 0x00, 0x00, 0x00, 0x00, 0x00, 0x00,
};

uchar code lian[]={ //横向取模
/*-- 文字: 联 --*/
/*-- 宋体 23; 此字体下对应的点阵为: 宽 x 高=31x31 --*/
/*-- 宽度不是 8 的倍数, 现调整为: 宽度 x 高度=32x31 --*/
0x00, 0x00, 0x00, 0x00, 0x00, 0x00, 0x00, 0x00, 0x00, 0x01, 0x81, 0xC0, 0x00, 0x0D, 0xC1, 0xF0,
0x00, 0x1E, 0xE1, 0xC0, 0x7F, 0xFB, 0xF3, 0x80, 0x1C, 0x70, 0x73, 0x80, 0x1C, 0x70, 0x77, 0x00,
0x1C, 0x70, 0x06, 0x70, 0x1C, 0x70, 0x0E, 0xF8, 0x1C, 0x7F, 0xFF, 0xD8, 0x1F, 0xF0, 0x1C, 0x00,

```



```
0x1C, 0x70, 0x1C, 0x00, 0x1C, 0x70, 0x1C, 0x00, 0x1C, 0x70, 0x1C, 0x18, 0x1C, 0x70, 0x1C, 0x3C,
0x1C, 0x7F, 0xFF, 0xFE, 0x1F, 0xF0, 0x1E, 0x00, 0x1C, 0x70, 0x1E, 0x00, 0x1C, 0x70, 0x3E, 0x00,
0x1C, 0x70, 0x3F, 0x00, 0x1C, 0x7E, 0x3B, 0x00, 0x1D, 0xF0, 0x3B, 0x80, 0x1F, 0xF0, 0x73, 0x80,
0x7C, 0x70, 0x71, 0xC0, 0x30, 0x70, 0xE1, 0xE0, 0x00, 0x71, 0xC0, 0xF0, 0x00, 0x73, 0x80, 0x7C,
0x00, 0x77, 0x00, 0x3C, 0x00, 0x7C, 0x00, 0x00, 0x00, 0x00, 0x00, 0x00, 0x00, 0x00, 0x00, 0x00,
};
```

```
uchar code xun[]={ //横向取模
/*— 文字: 讯 —*/
/*— 宋体 23; 此字体下对应的点阵为: 宽 x 高=31x31 —*/
/*— 宽度不是 8 的倍数, 现调整为: 宽度 x 高度=32x31 —*/
0x00, 0x00, 0x00, 0x00, 0x00, 0x00, 0x00, 0x00, 0x00, 0x00, 0x00, 0x00, 0x00, 0x00, 0x0F, 0x00, 0x00, 0x80,
0x07, 0x80, 0x01, 0xC0, 0x03, 0xFF, 0xFF, 0xE0, 0x03, 0xC0, 0x01, 0xC0, 0x01, 0x81, 0xE1, 0xC0,
0x00, 0x01, 0xE1, 0xC0, 0x00, 0x01, 0xC1, 0xC0, 0x00, 0x01, 0xC1, 0xC0, 0x00, 0x01, 0xC1, 0xC0,
0x03, 0xC1, 0xC1, 0xC0, 0x7F, 0xE1, 0xCD, 0xC0, 0x03, 0x81, 0xDF, 0xC0, 0x03, 0xBF, 0xFB, 0xC0,
0x03, 0x81, 0xC1, 0xC0, 0x03, 0x81, 0xC1, 0xC0, 0x03, 0x81, 0xC1, 0xC0, 0x03, 0x81, 0xC1, 0xC0,
0x03, 0x81, 0xC1, 0xCC, 0x03, 0x9D, 0xC1, 0xCC, 0x03, 0xB9, 0xC1, 0xEC, 0x03, 0xF1, 0xC0, 0xFC,
0x03, 0xE1, 0xC0, 0xFC, 0x03, 0xE1, 0xC0, 0xFC, 0x03, 0xC1, 0xC0, 0x7C, 0x01, 0x81, 0xC0, 0x3C,
0x00, 0x01, 0xC0, 0x1C, 0x00, 0x00, 0x00, 0x00, 0x00, 0x00, 0x00, 0x00, 0x00, 0x00, 0x00, 0x00, 0x00,
};
```

```
uchar code jing1[]={//横向取模
/*— 文字: 晶 —*/
/*— 宋体 12; 此字体下对应的点阵为: 宽 x 高=16x16 —*/
0x00, 0x00, 0x0F, 0xF0, 0x08, 0x10, 0x0F, 0xF0, 0x08, 0x10, 0x0F, 0xF0, 0x08, 0x10, 0x00, 0x00,
0x7E, 0x7E, 0x42, 0x42, 0x7E, 0x7E, 0x42, 0x42, 0x42, 0x42, 0x7E, 0x7E, 0x42, 0x42, 0x00, 0x00,
};
```

```
uchar code lian1[]={//横向取模
/*— 文字: 联 —*/
/*— 宋体 12; 此字体下对应的点阵为: 宽 x 高=16x16 —*/
0x01, 0x08, 0xFE, 0x8C, 0x44, 0x48, 0x44, 0x50, 0x7F, 0xFE, 0x44, 0x20, 0x44, 0x20, 0x7C, 0x20,
0x47, 0xFE, 0x44, 0x20, 0x4E, 0x20, 0xF4, 0x20, 0x44, 0x50, 0x04, 0x48, 0x04, 0x86, 0x05, 0x04};
```

```
uchar code xun1[]={//横向取模
/*— 文字: 讯 —*/
/*— 宋体 12; 此字体下对应的点阵为: 宽 x 高=16x16 —*/
0x40, 0x00, 0x27, 0xF8, 0x31, 0x08, 0x21, 0x08, 0x01, 0x08, 0xF1, 0x08, 0x17, 0xE8, 0x11, 0x08,
0x11, 0x08, 0x11, 0x08, 0x11, 0x08, 0x11, 0x0A, 0x15, 0x0A, 0x19, 0x0A, 0x11, 0x04, 0x00, 0x00};
```

```
void delay_ms(long int i)
{
    long int j,k;
    for(j=0;j<i;j++)
        for(k=0;k<110;k++);
}
```

```

//等待按键
void waitkey()
{
repeat:
    if(key==1) goto repeat;
    else delay_ms(1000);
}

/*写指令到LCD 模块*/
void transfer_command(int data1)
{
    char i;
    cs1=0;
    rs=0;
    for(i=0;i<8;i++)
    {
        sclk=0;
        if(data1&0x80) sid=1;
        else sid=0;
        sclk=1;
        data1=data1<<=1;
    }
    cs1=1;
}

```

```

/*写数据到LCD 模块*/
void transfer_data(int data1)
{
    char i;
    cs1=0;
    rs=1;
    for(i=0;i<8;i++)
    {
        sclk=0;
        if(data1&0x80) sid=1;
        else sid=0;
        sclk=1;
        data1=data1<<=1;
    }
    cs1=1;
}

```

```

//连写 2 个字节（即 16 位）数据到 LCD 模块
void transfer_data_16(uint data2)
{

```



```

transfer_data(data2>>8);
transfer_data(data2);
}

```

//LCD 初始化

```
void LCD_initial()
```

```
{
```

```
    delay_ms(50);
```

```
    reset=0;           //低电平: 复位
```

```
    delay_ms(100);
```

```
    reset=1;          //高电平: 复位结束
```

```
    delay_ms(100);
```

```
    //开始初始化:
```

```
transfer_command(0x11);
```

```
transfer_command(0xb1);
```

```
transfer_data(0x01);
```

```
transfer_data(0x2c);
```

```
transfer_data(0x2d);
```

```
transfer_command(0xb2);
```

```
transfer_data(0x01);
```

```
transfer_data(0x2c);
```

```
transfer_data(0x2d);
```

```
transfer_command(0xb3);
```

```
transfer_data(0x01);
```

```
transfer_data(0x2c);
```

```
transfer_data(0x2d);
```

```
transfer_data(0x01);
```

```
transfer_data(0x2d);
```

```
transfer_data(0x2d);
```

```
transfer_command(0xb4);
```

```
transfer_data(0x02);
```

```
transfer_command(0xb6);
```

```
transfer_data(0xb4);
```

```
transfer_data(0xf0);
```

```
transfer_command(0xc0);
```

```
transfer_data(0xa2);
```

```
transfer_data(0x02);
```

```
transfer_data(0x84);
```

```
transfer_command(0xc1);
```

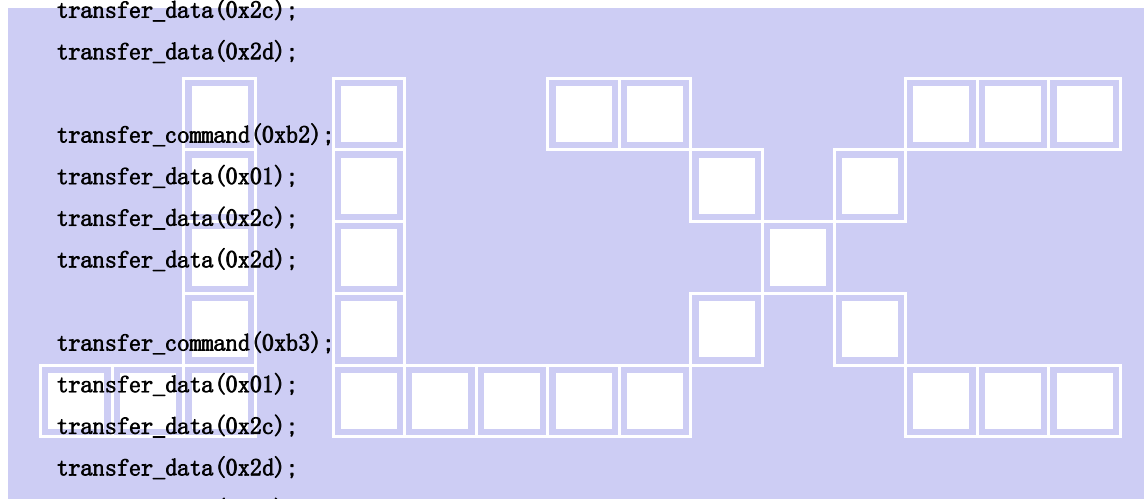

```
transfer_data(0xc5);
```

```
transfer_command(0xc2);
```

```
transfer_data(0x0a);
```

```
transfer_data(0x00);
```

```
transfer_command(0xc3);
```

```
transfer_data(0x8a);
```

```
transfer_data(0x2a);
```

```
transfer_command(0xc4);
```

```
transfer_data(0x8a);
```

```
transfer_data(0xee);
```

```
transfer_command(0xc5);
```

```
transfer_data(0x0e);
```

```
transfer_command(0x36); //行扫描顺序, 列扫描顺序, 横放/竖放
```

```
transfer_data(CW180); //MX=1 (行地址顺序: 从左到右), MY=1 (列地址顺序: 从上到下), MV=0 (竖放), ML=0 (纵向刷新: 从上到下), RGB=1 (依次为 RGB), MH=0 (横向刷新顺序: 从左到右)
```

```
//定义: "normal" 就是 "0xc8" —— 正常竖放;
```

```
//定义: "CW180" 就是 "0x08" —— 在正常竖放基础上转 180 度竖放;
```

```
//定义: "CCW90" 就是 "0xa8" —— 在竖放基础上逆时针转 90 度横放;
```

```
//定义: "CW90" 就是 "0x68" —— 在竖放基础上顺时针转 90 度横放;
```

```
transfer_command(0xff);
```

```
transfer_data(0x40);
```

```
transfer_data(0x03);
```

```
transfer_data(0x1a);
```

```
transfer_command(0xfc);
```

```
transfer_data(0x11);
```

```
transfer_data(0x17);
```

```
transfer_command(0xf0);
```

```
transfer_data(0x01);
```

```
transfer_command(0x3a);
```

```
transfer_data(0x05);
```

```
transfer_command(0xf6);
```

```
transfer_data(0x00);
```

```
transfer_command(0xe0);
```

```
transfer_data(0x02);
```

```
transfer_data(0x1c);
```

```
transfer_data(0x07);
```



```

transfer_data(0x12);
transfer_data(0x37);
transfer_data(0x32);
transfer_data(0x29);
transfer_data(0x2d);
transfer_data(0x29);
transfer_data(0x25);
transfer_data(0x2b);
transfer_data(0x39);
transfer_data(0x00);
transfer_data(0x01);
transfer_data(0x03);
transfer_data(0x10);
    
```

```

transfer_command(0xe1);
transfer_data(0x0b);
transfer_data(0x14);
transfer_data(0x09);
transfer_data(0x26);
transfer_data(0x27);
transfer_data(0x22);
transfer_data(0x1c);
transfer_data(0x20);
transfer_data(0x1d);
transfer_data(0x1a);
transfer_data(0x25);
transfer_data(0x2d);
transfer_data(0x06);
transfer_data(0x06);
transfer_data(0x02);
transfer_data(0x0f);
    
```

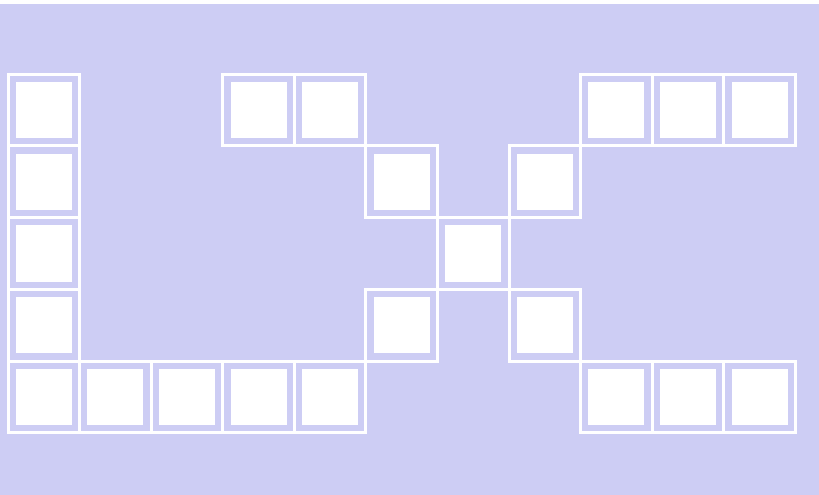

```

transfer_command(0x2a); //定义 X 地址的开始及结束位置
transfer_data(0x00);
transfer_data(0x00);
transfer_data(0x00);
transfer_data(0x7F);
    
```

```

transfer_command(0x2b); //定义 Y 地址的开始及结束位置
transfer_data(0x00);
transfer_data(0x00);
transfer_data(0x00);
transfer_data(0x7F);
    
```

```

transfer_command(0x29); //开显示
    
```

```

}
    
```

//定义窗口坐标: 开始坐标 (XS,YS)以及窗口大小 (x_total,y_total)

```
void lcd_address(int XS,int YS,int x_total,int y_total)
{
    int XE,YE;
    XS=XS+2;
    YS=YS+1;
    XE=XS+x_total-1;
    YE=YS+y_total-1;
    transfer_command(0x2a);    // 设置 X 开始及结束的地址
    transfer_data_16(XS);    // X 开始地址(16 位)
    transfer_data_16(XE);    // X 结束地址(16 位)
    transfer_command(0x2b);    // 设置 Y 开始及结束的地址
    transfer_data_16(YS);    // Y 开始地址(16 位)
    transfer_data_16(YE);    // Y 结束地址(16 位)
    transfer_command(0x2c);    // 写数据开始
}
```

//将单色的 8 位的数据 (代表 8 个像素点) 转换成彩色的数据传输给液晶屏

```
void mono_transfer_data(int mono_data,int font_color,int back_color)
{
    int i;
    for(i=0;i<8;i++)
    {
        if(mono_data&0x80)
        {
            transfer_data_16(font_color);    //当数据是 1 时, 显示字体颜色
        }
        else
        {
            transfer_data_16(back_color);    //当数据是 0 时, 显示底色
        }
        mono_data<<=1;
    }
}
```

//显示单一色彩

```
void display_color(int XS,int YS,int x_total,int y_total,int color)
{
    int i,j;
    lcd_address(XS,YS,x_total,y_total);
    for(i=0;i<128;i++)
    {
        for(j=0;j<128;j++)
        {
            transfer_data_16(color);
        }
    }
}
```



```

    }
}

//显示 32x32 点阵的汉字，或相当于 16x16 点阵的图像。温馨提示，数据指针*dp 是字符型数据（char *dp）
void disp_32x32(int x,int y,char *dp,int font_color,int back_color) //int x X轴坐标, int y,Y轴坐标
{
    int i,j;
    lcd_address(x,y,32,32);
    for(i=0;i<32;i++)
    {
        for(j=0;j<4;j++)
        {
            mono_transfer_data(*dp,font_color,back_color);
            dp++;
        }
    }
}

```

```

//显示 16x16 点阵的汉字，或相当于 16x16 点阵的图像。温馨提示，数据指针*dp 是字符型数据（char *dp）
void disp_16x16(int x,int y,char *dp,int font_color,int back_color) //int x X轴坐标, int y,Y轴坐标
{
    int i,j;
    lcd_address(x,y,16,16);
    for(i=0;i<2;i++)
    {
        for(j=0;j<16;j++)
        {
            mono_transfer_data(*dp,font_color,back_color);
            dp++;
        }
    }
}

```

```

//主程序
void main(void)
{
    while(1)
    {
        LCD_initial(); //初始化
        display_color(0,0,128,128,blue);
        disp_32x32(16+32*0,32,jing,red,white);
        disp_32x32(16+32*1,32,lian,red,white);
        disp_32x32(16+32*2,32,xun,red,white);
        disp_16x16(8+16*2,8,jing1,red,white);
        disp_16x16(8+16*3,8,lian1,red,white);
    }
}

```

```
disp_16x16(8+16*4, 8, xun1, red, white);  
waitkey();  
display_color(0, 0, 128, 1128, red);  
waitkey();  
display_color(0, 0, 128, 128, green);  
waitkey();  
display_color(0, 0, 128, 128, blue);  
waitkey();  
}  
}
```

-END-

